

FATIHA KOUIDMI DELAA* & ALI KAMAL ALTAWANSY**

*Universitat Jaume I. **Universidad Damanhour

Exploring the sustainable contrast between age friendly public areas in Mediterranean cities: case studies

ABSTRACT

This article aims to evaluate a site's capacity to meet the needs of the elderly in urban planning and is intended to aid urban planners in the use of urban space. The general objective of the study is to identify the specific needs of the elderly in two samples in two countries, Egypt and Spain, and develop an accessibility plan to cater to their needs. The research was based on analysis of existing literature and archival materials, as well as in situ, through observation and photographic documentation, during the investigation in Spain and Egypt. The study employed a comparative methodology to compare public spaces in two areas of two countries, Egypt and Spain. The results showed that both samples have good urban planning and offer better access to public spaces. However, the social results in Castelló were higher than in Sheikh Zayed, as the number of the elderly in Sheikh Zayed is relatively small compared to Castelló. Overall, the study emphasises the need to ensure designs that are mindful of the elderly physical environment to ensure their safety and fulfilment of the SDGs.

RESUMEN

Explorando el contraste sostenible entre las áreas públicas adaptadas a las personas mayores en las ciudades mediterráneas: estudios de caso.- Este artículo tiene como objetivo evaluar la capacidad de un sitio para satisfacer las necesidades de las personas mayores en la planificación urbana y pretende ayudar a los planificadores urbanos en el uso del espacio urbano. El objetivo general del estudio es identificar las necesidades específicas de las personas mayores en dos muestras de dos países, Egipto y España, y desarrollar un plan de accesibilidad para atender a sus necesidades. El estudio empleó una metodología comparativa de los espacios públicos en dos áreas de dos países, Egipto y España. Los resultados mostraron que ambas muestras cuentan con una buena planificación urbana y ofrecen un mejor acceso a los espacios públicos. Sin embargo, los resultados sociales en Castelló fueron superiores a los de

Sheikh Zayed, ya que el número de personas mayores en Sheikh Zayed es relativamente pequeño en comparación con Castelló. En general, el estudio enfatiza la necesidad de garantizar diseños que tengan en cuenta el entorno físico de las personas mayores para garantizar su seguridad y el cumplimiento de los ODS.

RÉSUMÉ

Explorer le contraste durable entre les espaces publics adaptés aux personnes âgées dans les villes méditerranéennes : études de cas.- Cet article vise à évaluer la capacité d'un site à répondre aux besoins des personnes âgées en matière d'urbanisme et a pour vocation d'aider les urbanistes dans l'usage de l'espace urbain. L'objectif général de l'étude est d'identifier les besoins spécifiques des personnes âgées dans deux échantillons de deux pays, l'Égypte et l'Espagne, et d'élaborer un plan d'accessibilité pour répondre à leurs besoins. L'étude a utilisé une méthodologie comparative pour comparer les espaces publics dans deux régions de deux pays, l'Égypte et l'Espagne. Les résultats ont montré que les deux échantillons ont une bonne planification urbaine et offrent un meilleur accès aux espaces publics. Cependant, les résultats sociaux à Castelló étaient plus élevés qu'à Sheikh Zayed, car le nombre de personnes âgées à Sheikh Zayed est relativement faible par rapport à Castelló. Dans l'ensemble, l'étude souligne la nécessité de garantir des conceptions qui tiennent compte de l'environnement physique des personnes âgées afin de garantir leur sécurité et la réalisation des ODD.

KEYWORDS/PALABRAS CLAVE/MOTS CLÉ

Comparative study, Mediterranean countries, open urban spaces, elderly urban needs.

Estudio comparativo, países mediterráneos, espacios urbanos abiertos, necesidades urbanas para las personas mayores.

Étude comparative, pays méditerranéens, espaces urbains ouverts, besoins urbains des personnes âgées.

I. INTRODUCTION

To improve the urban and architectural development program, it is very important to study the environ-

mental geographical part together with the social relationship (ZULFIDA et al., 2023). for it, it strives to produce knowledge and policies that empower local communities to leverage their resources and diversity to promote

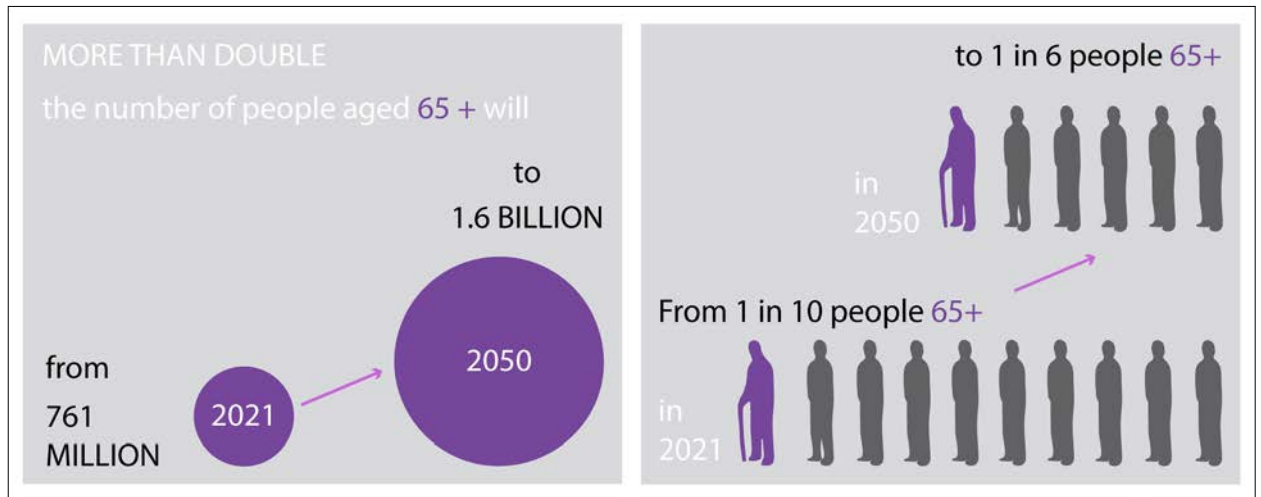

FIG. 1. Population ageing: global ageing growth ratio (left); societies will be older (right). Source: United Nations, global ageing growth ratio [consulted: 10/03/2023].

the overall well-being and quality of life of all residents (SANTOS et al., 2022). As the number of older people increases, the need for effective health care and social services for this population will also increase. The World Health Organisation (WHO) has identified older adults as a priority population for health care and has called for increased investments in health care for older adults (WHO, 2016). Population ageing and urbanisation are two global trends that together comprise major forces shaping the 21st century. At the same time as cities are growing, their share of residents aged 60 years, and more is increasing (WHO, 2007). In the United States, the Health and Human Services Administration (HHS) has developed a national plan for health care for older adults. The HHS plan calls for increased investments in health care for older adults, including improvements in primary care, prevention, and chronic disease management (WHO, 2018).

Demographic growth and modernity in the urban landscape, emphasise the need to develop architectural and urban standards for sustainable urbanisation (ABBAS & HUSSEIN, 2023). The implications of this demographic change are far-reaching and will require planning for the accessibility and inclusion of older people in the urban space (JARZEBSKI et al., 2021). It is important to determine the overall well-being of individuals and communities, and it is suggested that this understanding should be considered when designing communities and allocating resources to create more prosperous and healthy places for current and future generations (SCOTT, 2021).

The ageing of the population will have a profound impact on many aspects of society, including healthcare,

transportation, housing, and social services. It is the ability to make prudent choices in our everyday lives that fosters human growth and enhances the experience of ageing gracefully (GILROY & SCHOFIELD, 2015). Planning for the accessibility of older people in the urban space will require the consideration of a range of factors, including the physical and mental health of older people, their transportation needs, their ability to access and navigate the built environment, and their social and emotional needs. The accessibility measures are a useful tool for planners and policymakers in the social evaluation of urban structure (BLACK & CONROY, 1977). The first step to making a unified result that benefits all elderly people is to understand what accessibility means in each country. It is recommended to use the WHO framework for age-friendly cities/communities to revitalise town centres in the post-Covid-19 world. This approach will take a comprehensive view that acknowledges the importance of place for healthy living, community engagement, social participation, and allowing older individuals to “age in place” (PHILLIPS et al., 2021). Different countries may have different definitions of accessibility, as well as different standards and regulations. For example, some countries may have stricter rules regarding wheelchair access, while others may have more lenient rules. Ensuring enabling environments for ageing populations is a critical issue around the world (O’BRIEN, 2014). It is important to understand these differences to come up with a unified result that is beneficial to all elderly people. The rapid ageing of the population is a growing trend globally, with developing countries experiencing

this change more rapidly than developed countries (OMS 2011). The population of people over 60 years old will increase significantly by 2050. Longer life expectancy is a global phenomenon affecting both developed and developing countries. This study is expected to continue in the future, with no indication of reversing (PARKINSON et al., 2013). People aged 65 years or older worldwide are expected to double over the next three decades, reaching 1.6 billion in 2050, when older people will account for more than 16 % of the global population (UN, 2023) (Fig. 1).

II. SPECIFIC THEORETICAL FRAMEWORK: SUSTAINABLE NORMS AND LAWS OF THE ACCESSIBILITY OF ELDERLY IN AN URBAN ENVIRONMENT IN TWO COUNTRIES, SPAIN AND EGYPT

Once the differences between countries are understood, the next step is to identify the specific needs of elderly people in each country. This can include things like physical access, safety, and transportation. Understanding the needs of the elderly people in each country will help to develop an accessibility plan that is tailored to the needs of each country.

These means are included in SDGs “Sustainable Development Goals”:

- N° 3. Ensure healthy lives and promote well-being for all at all ages.
- N° 11. Make cities and human settlements inclusive, safe, resilient, and sustainable.

Egypt issued the Housing and Building National Research Centre (HBRC) of Egyptian code no. (601) for outdoor spaces and building design for handicaps in 2003, and Law N° 10 of (2018) Promulgating the Law on the Rights of Persons with Disabilities. The code requires many design considerations for these outdoor spaces, circulation paths, dimensions, travelling distance, spans, finishing materials, seating areas, handrails, sheds, etc., to suit this segment needs, including the elderly (HBRC, 2017), (Fig. 2).

By incorporating sustainability practices into their urban development, cities strive to ensure that their growth is environmentally friendly and socially responsible. They actively seek ways to apply principles outlined in agreements, manuals, and norms that promote sustainability. Cities that embrace sustainability consider various

aspects of urban life, such as transportation, waste management, and green spaces. They aim to minimise their ecological footprint while maximising social, economic, and environmental benefits for their residents.

Urban planners and policymakers work closely with experts and stakeholders to develop strategies that align with sustainable development goals. They may follow manuals and guidelines that provide recommendations and best practices for creating sustainable communities. These manuals often cover sustainable infrastructure, green building designs, water, waste reduction, and public transportation improvements.

Cities also comply with norms and regulations imposed by governing bodies and local authorities to ensure sustainability. These norms may include building codes, emissions standards, waste management regulations, and environmental impact assessments (DÁVALOS-PITA, 2022).

As for Spain, there are numerous standards and draft standards related to accessibility requirements in many areas: from universal accessibility and design for all, to its application in building and urban planning, smart cities, etc. The analysis of these standards is useful to analyse the minimum requirements that built spaces must meet, to meet adequate accessibility conditions. Therefore, there are many standards to transform the public environment into an accessible environment such as UNE and ISO standards: UNE 41500-2001 IN Accessibility in building and urban planning, UNE 41510 Accessibility in urban planning, UNE 41524 Accessibility in the building, UNE-ISO 21542 Accessibility of the built environment. (KOUIDMI, 2022). The latest law on accessibility in Spain is Law 6/2022, of 31st of March, modifying the Consolidated Text of the General Law on the rights of people with disabilities and their social inclusion, approved by Royal Legislative Decree 1/2013, of November 29, to establish and regulate accessibility. The law aims to establish and regulate cognitive accessibility and its conditions of requirement and application. Additional provisions are mentioned, such as carrying out specific studies on cognitive accessibility and creating a regulation of basic conditions of cognitive accessibility¹.

To achieve an accessible urban environment, a concrete urban planning plan should be followed. Urbanism allows designing the essential elements of territorial planning in a neighbourhood, considering the universal accessibility that should be integrated into the public

¹ <<https://www.boe.es/buscar/act.php?id=BOE-A-2022-5140>>.

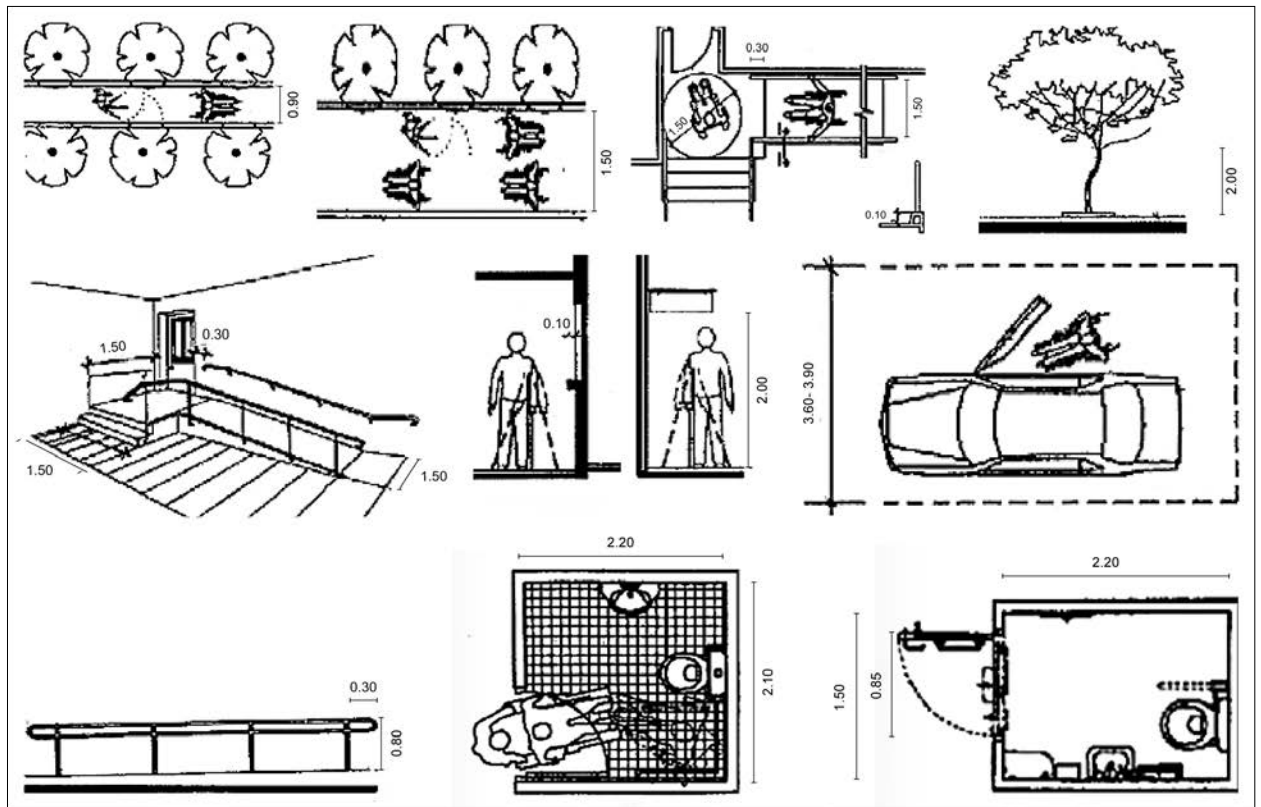

FIG. 2. Outdoor spaces feature standards at Egyptian handicap code, from left to right and from up to down: pass minimum width, one and two-way pass (two first images); entrance approach detail and plinth detail; walk height clearance; entrance approach detail; prominent and outdoor walk obstacles; parking minimum width; handrail detail; bathrooms, with door that opens inwards and outwards in the last image. All dimensions are expressed in meters. Source: Housing and Building national Research Center of Egyptian code number 601 for outdoor spaces and building design for handicaps, 2017.

space. The fundamental characteristic of this type of space is that it is used by people, from which derives the need to address a very diverse problem in it depending on the different types of limitations or disabilities that hinder the mobility of users. It is very important to relate accessibility to other matters of interest to promote full inclusion, such as personal autonomy, the SDGs to obtain a sustainable environment (SHAN et al., 2020).

The following (Fig. 3) show the Urbanised public spaces in Spain, the accessibility in the public urban environment with the urban regulations.

There are previous studies treating this subject adopted many visions such as enhancing pedestrian accessibility and the environmental quality of age-friendly cities in Spain by reducing noise and/or air pollution through the installation of urban elements (ramps, escalators, elevators, vegetation, etc.), (DELGADO-ENALDES et al., 2023). Some research used investigative and

analytical methods (RAVI et al., 2021). Some of it uses observations and interviews and the involvement of multi-stakeholders from local government, non-profits and businesses to improve the quality of life for the elderly (THANG et al., 2023). Some of them addressed the reasons that encourage the elderly to go out to public spaces in the open air, especially in crowded cities such as Hong Kong and how to achieve thermal comfort for them (PENG & MAING, 2021). And understand the effects of public open space on elderly mental health and functional ability (LIU et al., 2023). To make urban residential areas more elderly-friendly, it is important to consider the emotional needs of the elderly in the planning process. This includes providing a safe environment to promote physical activity and improving access to social support networks. It is also important to consider the psychological and social needs of the elderly, such as providing opportunities for social interaction,

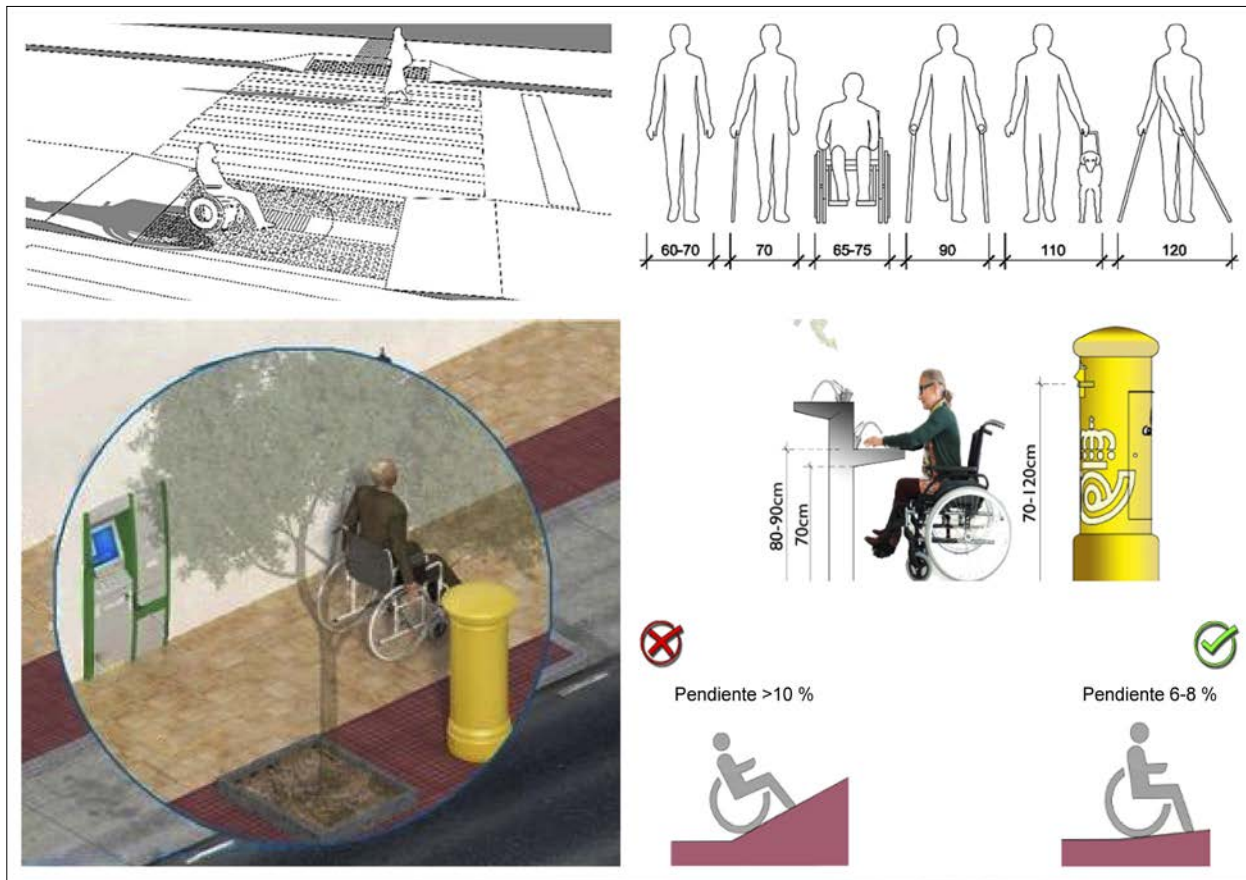

FIG. 3. Accessibility in public urban environment in Spain in accordance with urban regulations: accessible outdoor walk (left); dimensional criteria (top right); elements of urban furniture and accessible ramp slopes, (bottom right). Sources: Agenda Urbana, 2021; Fundación ONCE, 2011 (<https://www.google.com/search?q=MANUAL+DE+AccESIBILIDAD+PARA+TECNICOS+MUNICIPALES&rlz=1C5CHFA_enES689ES689&oq=MANUAL+DE+AccESIBILIDAD+PARA+TECNICOS+MUNICIPALES&aqs=chrome.69j59j0i22i30.964j0j7&sourceid=chrome&ie=UTF-8>, page 221); Ayuntamiento de Madrid, 2022, page 72; and Junta de Extremadura, 2022, pages 24 and 25.

a sense of belonging, and activities that stimulate their cognitive abilities, these findings provide valuable information for creating more age-friendly societies and age-friendly urban transformations (LU et al., 2023). In addition, providing access to services and resources that meet the needs of the elderly can help to improve their quality of life, it is essential to create a pleasant and stimulating environment for the elderly. This could include planting trees, creating green spaces and gardens, or providing access to recreational activities². Furthermore, providing adequate lighting, good air quality, and other amenities can help reduce social isolation and

improve the quality of life for the elderly. Such environmental improvements can be beneficial for all city dwellers, including the elderly, and can help to create an environment that fosters a sense of belonging and well-being (ZHONG et al., 2021).

III. PURPOSE AND METHODOLOGY

The research methodology adopted in the study is based on a comparative approach, whereby public spaces in two regions of two different countries, Egypt and Spain, are evaluated and compared. The hypothesis of this article is that there are similarities and differences in the availability of public spaces for older adults in the two samples for Egypt and Spain.

² Ayuntamiento de Castellón de la Plana: *Ciudades amigables con las personas mayores*, <https://extranet.who.int/agefriendlyworld/wp-content/uploads/2016/01/Ciudad_Amigable_Mayores_Diagnosis.pdf>.

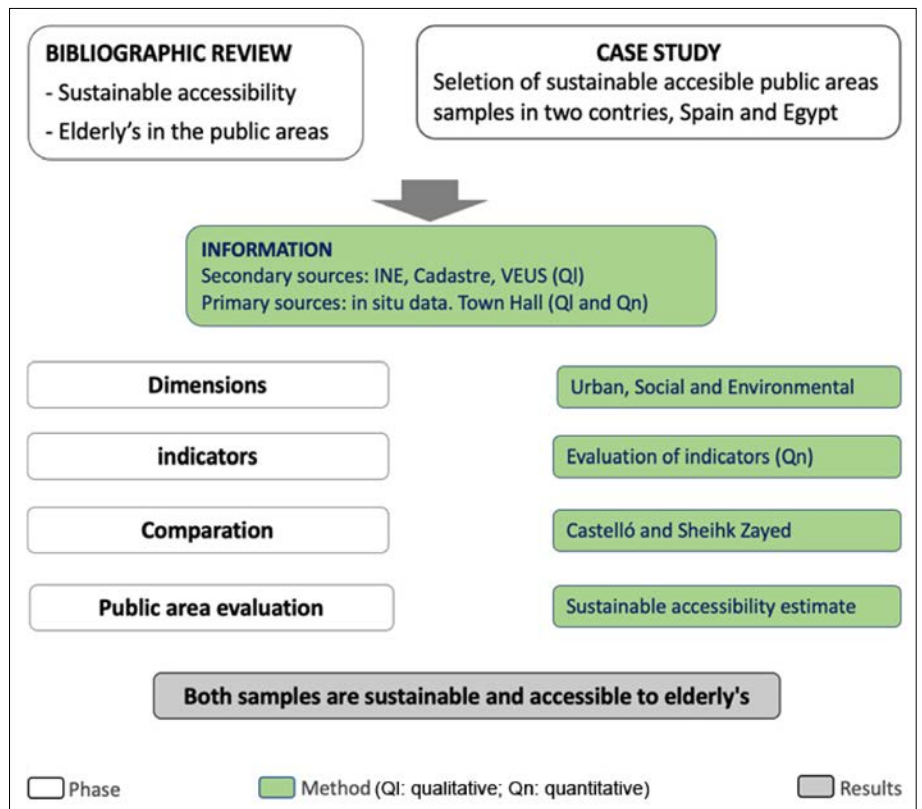

FIG. 4. The outline of study.
Authors' own creation.

The dimensions of this study focus on three parts. Firstly, the urban dimension provided an in-situ evaluation of urban spaces adapted for older people in public areas (the samples from Spain and Egypt). Secondly, the social dimension that indicates the percentage of the elderly in the two samples. And, finally, the environmental dimension where meteorological data is used to know the climatological part in the two samples. In addition, different evaluation indicators are compared, such as environmental considerations, health, accessibility, privacy, security, acoustic insulation, sports, social activities, maintenance, and furniture, among others. The goal is to achieve optimal evaluation criteria for these public spaces and ensure designs that consider the physical environment of older people to ensure their safety and meet the Sustainable Development Goals (SDGs).

The study aims to provide a comprehensive and comparative analysis of the public spaces in both regions, to identify the similarities and differences between them. The research methodology consists of two complex main steps:

1. Selection of the study areas, collection and analysis of data and Identification of the main features

and characteristics of the public spaces in the study areas.

2. Comparative analysis of the public spaces and results of comparisons in the study areas.

The study areas selected for the research are two samples in Egypt and Spain that are representative of the different types of public spaces in each country. The selected samples are:

- Open urban spaces in “Residential complex” at Castelló de la Plana in Spain.
- Open urban spaces in “Garden Housing” at Sheikh Zayed city in Egypt.

The data collection and analysis process consisted of several steps, including the collection of secondary data from various sources and the analysis of primary data on-site. The identification of the main features and characteristics of the public spaces in the study areas involved the analysis of various factors, such as the size and location of the public spaces, the types of activities that take place in them, and the level of accessibility

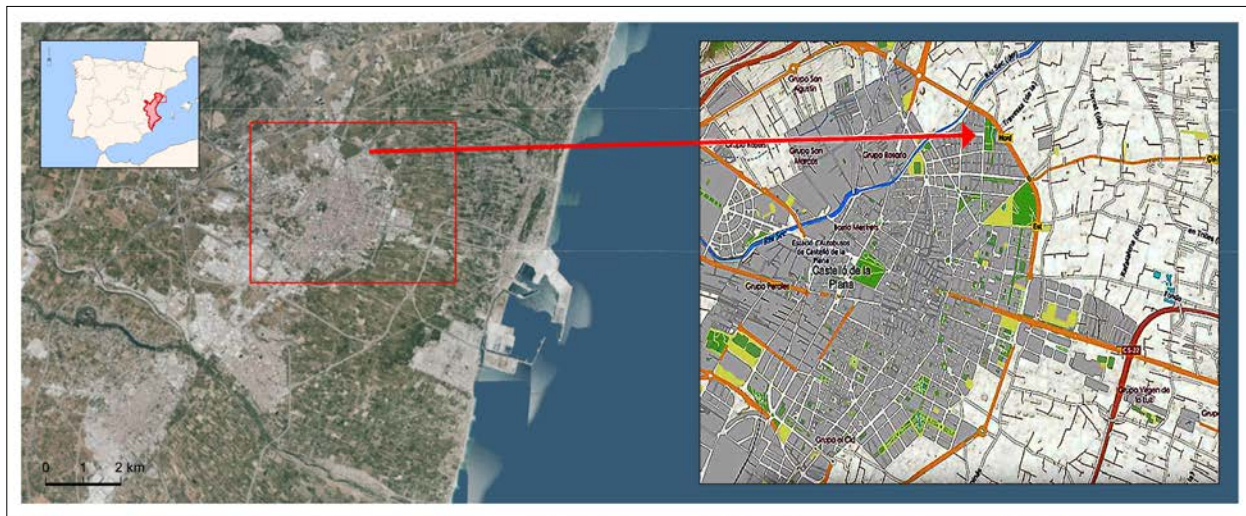

FIG. 5. Castellón de la Plana city aerial view (left) and chosen Location (right), Spain. Source: Visor de Espacios Urbanos Sensibles (VEUS, visor cartográfico del distrito 7 de la ciudad de Castellón de la Plana, <<https://calab.es/observatorio-del-habitat/veus/>> [consulted: 15/05/2023].

and connectivity of the public spaces to the surrounding areas. The methodology should be applied to compare the study areas based on the collected data. The results should be analysed to identify the similarities and differences between the study areas. Finally, the results should be written up in a manner that is easy to understand and interpret. The outline of this study is shown in the following figure (Fig. 4).

IV. SELECTION AND COMPARISON CRITERIA

There are three dimensions (Frame III and Frame IV), and each dimension is composed of indicators. Chosen criteria based on the need to create a safe, comfortable, and sustainable living environment for all residents. The urban pattern was chosen to ensure that the urban area is laid out in a way that is efficient for movement, provides access to green areas, and is aesthetically pleasing. The green areas provide a place for recreation and relaxation, as well as a habitat for wildlife to thrive. Accessibility for people with disabilities was chosen to make sure that those with disabilities have access to all areas of the city. Noise insulation was chosen to minimise the noise pollution in the city and make it more pleasant to live in. Accessible pavements and ramps provide safe pathways for people to move around the city, while pavement maintenance ensures that the pathways are kept in good condition. Cleanliness was chosen to ensure that the city is kept clean and free of pollutants, while urban equipment

was chosen to provide amenities such as benches, street-lights, and playgrounds. Heat, relative humidity, and solar radiation were chosen to assess the climate in the city and ensure that it is comfortable for all residents. Health was chosen to ensure that the city provides adequate resources to promote health and wellness among its inhabitants. Finally, ageing rates, housing levels, and targeted social activities were chosen to assess the overall quality of life in the city and help ensure that it is a place where people can thrive.

A. URBANISM: we chose these criteria because they are all essential aspects of the urban environment that need to be considered when creating a liveable city. The urban pattern, green areas, and noise insulation are important for creating a pleasant environment, while accessibility for people with disabilities, accessible pavements, and accessible ramps ensure that all members of society can easily navigate the city. Cleanliness and urban equipment provide an opportunity to make the city more attractive and enjoyable. Health is an important factor in determining how sustainable and liveable the city is (Frame III).

B. SOCIAL: we chose these criteria because they are all related to the social aspects of the city. Ageing rates and housing levels provide insight into the demographics of the city, while targeted social activities can help bring people together and create a sense of community (Frame III).



FIG. 6. Residential complex aerial view, Castelló de la Plana, Spain. Source: VEUS2 [consulted :15/05/2023].

C. ENVIRONMENTAL: we chose these criteria because they all have an impact on the health and well-being of the city’s inhabitants. Heat, relative humidity, and solar radiation all affect the temperature and comfort of the city (Frame IV).

1. SPAIN MODEL

The study case, “Residential complex” at the 7th District in Castelló de la Plana, Valencian Community in Spain (Fig. 5).

FRAME I. Residential complex

Uses	Area (Acres)	%
Total Lot Size Area	14.83	100 %
Footprint Area	3.13	21.10
Internal Pedestrian Sidewalk	1.60	10.78
Gardens	5	33,71
External Pedestrian Sidewalk	2.50	16.85
Parking Area (200 places)	2.60	17.53

Source: Viewer of Sensitive Urban Spaces of the Valencian Community (VEUS), <<https://visor.gva.es/visor/index.html?idioma=es&capasids=VEUS;4,3,2,1,0>> [consulted: 15/05/2023].

- Collection and analysis of data. This case study is on the outskirts of Castelló de la Plana. It is characterised by low building density and high infrastructure. It is a residential complex on an area of about (14.83) acres at the north axis of the city (Fig. 6); consisting of (37) buildings; (2) primary schools; (1) church; (26) villas and (6) apartment with a footprint (21.10%), and more than 78 % open areas (Frame I).

A) *In situ study of accessibility in the urban space of district 7 in Spain “residential complex”*

In terms of accessibility, the study found that the district has accessibility in parks, sidewalks, and ramps, among others, and has many green spaces, which can facilitate access to them for people with reduced mobility. In addition, the district’s road network is characterised by a high number of parking spaces, which helps reduce parking obstacles, which can limit the mobility of people with reduced mobility.

To see the reality of accessibility in this area, a set of photos has been prepared that show the installation of ramps, green spaces, cleanliness, as well as the most accessible pedestrian routes, as shown in the following (Fig. 7).

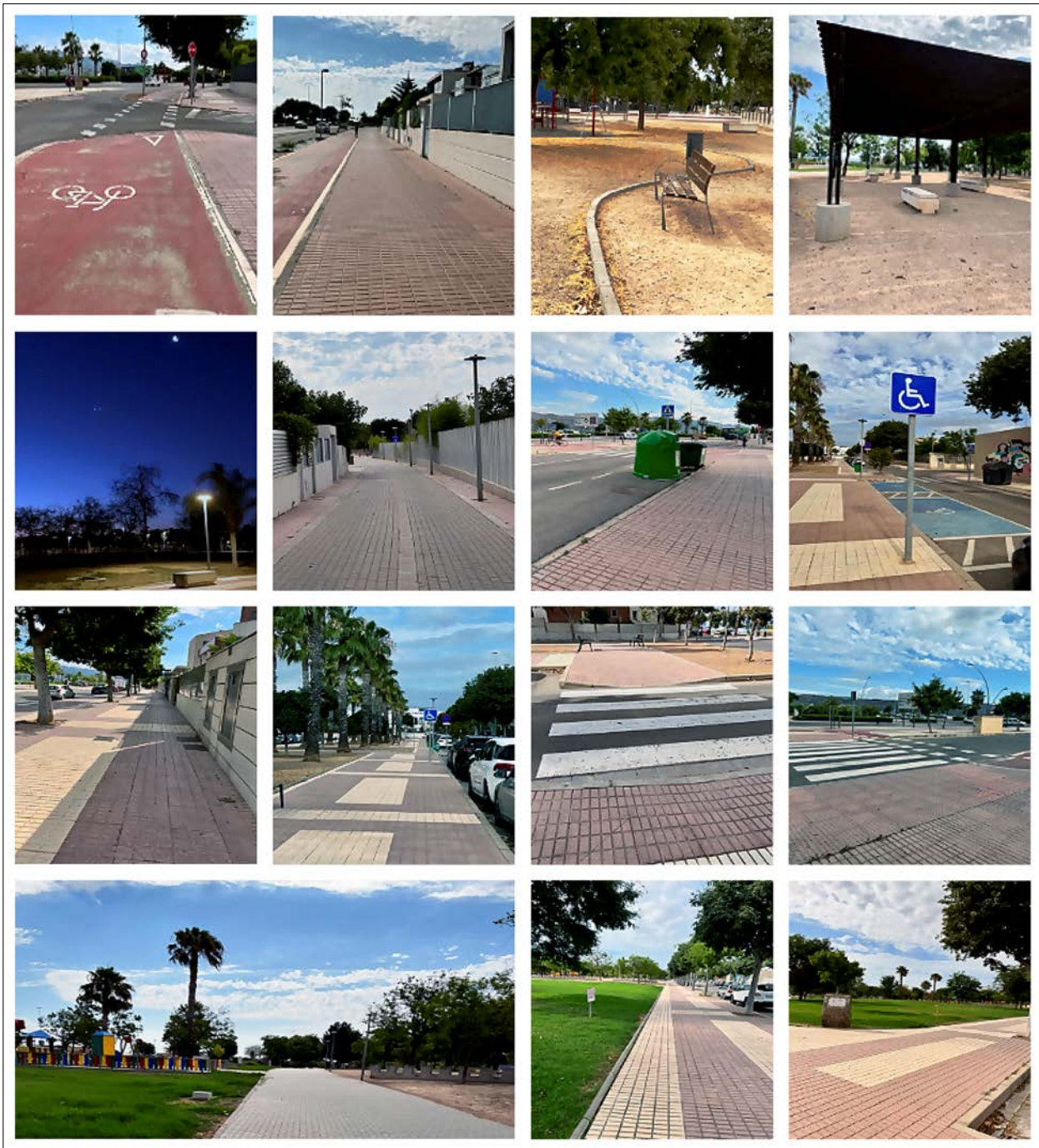

FIG. 7. Open urban spaces: outdoor activities, features, and furniture. From left to right and from up to down: playing sports and walking (two first images); wooden sofa; sitting and meeting; streetlights columns (two images); cleanliness; accessibility; accessible pavements; parking area; accessible ramps (two images) and greens areas in three last images. Authors' photographs.

2. EGYPTIAN MODEL

The study case “Garden Housing” at Sheikh Zayed town, is in the area outside of the Giza Governorate in Egypt. Sheikh Zayed City is located within the geograph-

ical scope of the 6th of October area has many green spaces and accessibility in most of them (Fig. 8).

- Collection and analysis of data. It is a luxury housing project on an area of about (21) acres at the central



FIG. 8. Sheikh Zayed city aerial view (left) and chosen location (right), in Egypt. Source: Google Maps, <<https://maps.app.goo.gl/zueyMmTbAt-w27tCd7>> [consulted: 18/12/2023].



FIG. 9. Partial Urban Garden Housing Plan in Sheikh Zayed, Egypt. In the miniature, general layout of the city. Source: New Urban Communities Authority, Sheikh Zayed City Development Authority, Giza, Egypt, <http://newcities.gov.eg/know_cities/Sheikh_Zayed/default.aspx> [accessed: 05/02/2023].



FIG. 10. Open urban spaces: outdoor activities, features and furniture. Up on the left, sitting and meetings; walking and outdoor social activities (the next two images); pergola with seats for social activities (next image); passage and promenade (image to its right); internal and external shaded seats (next row); parking area (down on the left); smooth stairs and handy cap ramps (middle); pedestrian sidewalk (last image). Authors' photographs.

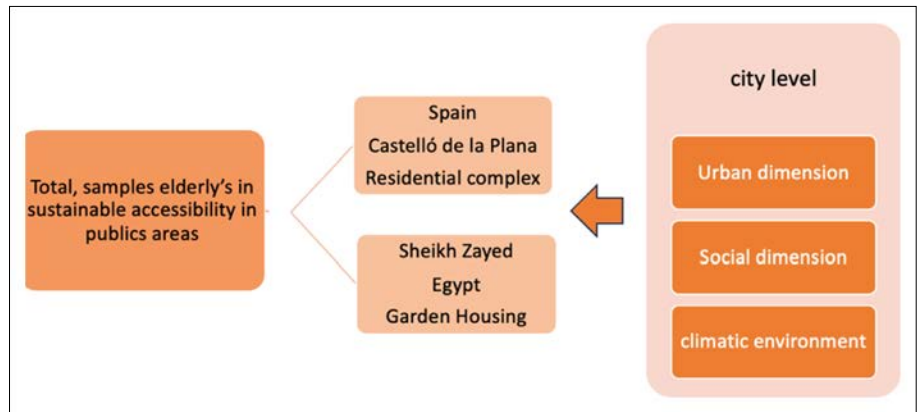

FIG. 11. Conceptual framework. Authors' own creation.

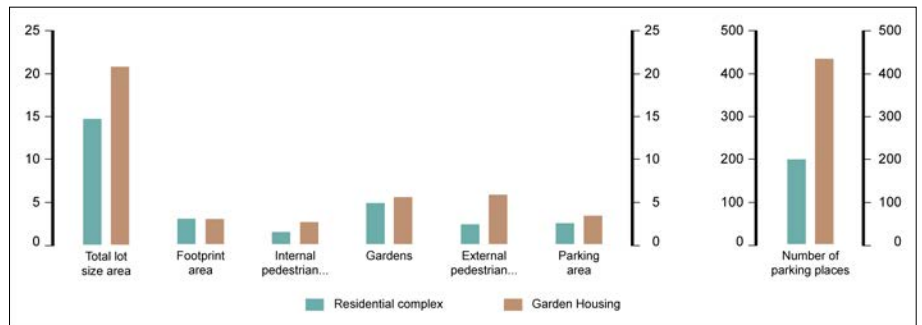

FIG. 12. Comparison of uses in case studies. Developed by authors.

axis of the city (Fig. 9) consisting of (31) buildings; (420) apartments with a footprint (14.83%) and more than 85% open areas (Frame II)³.

FRAME II. Garden Housing Project Data

Uses	Area (Acres)	%
Total Lot Size Area	20.91	100 %
Footprint Area	3.1	14.83 %
Internal Pedestrian Sidewalk	2.74	12.1 %
Gardens	5.65	27.02 %
External Pedestrian Sidewalk	5.94	28.4 %
Parking Area (435places)	3.49	16.69 %

Source: New Urban Communities Authority, Sheikh Zayed City Development Authority, <http://www.newcities.gov.eg/english/New_Communities/Zayed/default.aspx> [consulted: 05/02/ 2023].

A) *In situ study of accessibility in the urban space of Sheikh Zayed city in Egypt*

The area is known for its green spaces and accessibility in most of them. The case study is home to many

parks, gardens, and other green spaces, as well as to many residential areas, commercial areas, and other amenities. The area is well-connected to the rest of the city by public transportation and is also home to many highways and other roads (Fig. 10).

IV. A COMPARATIVE PERSPECTIVE

With all the data prepared, the research framework is shown in Figure 11. The urban dimension, the social dimension and the climatic dimension are shown to compare the indicators for the accessibility of older people in Mediterranean cities. This part compares both models using the mentioned chosen comparison criteria (urbanism, social, environmental).

A) URBANISM: In both Egypt and Spain models of case study, there are almost the same results: good urban planning (Frame III) and (Fig. 12).

B) SOCIAL: There are some differences in the social results. The percentage of social results is higher in Spain than in Egypt. The number of elderly people is very high in the case study of Spain, where it can reach 21.5% (Frame III).

³ New Urban Communities Authority, Sheikh Zayed City Development Authority, Giza, Egypt <http://newcities.gov.eg/known_cities/Sheikh_Zayed/default.aspx>, 5th February 2023.

FRAME III. Urbanism, health and Social Comparison Criteria of urban space

Dimensions	Criteria	Spain, Residential complex	Egypt, Garden Housing
Urbanism	Urban pattern	Open Form	Open Form
	Green areas availability	100 %	100 %
	Accessibility for people with disabilities	100 % for people with disabilities and old people	100 % for people with disabilities and old people
	Noise Insulation	Required In principal ways and schools	In principal ways (located in the central axis of the city)
	Accessible pavements	All pavements are accessible	All pavements are accessible
	Pavements maintenance	100 %	Approximately \approx 95 %
	Accessible ramps	All ramps are accessible	All ramps are accessible but some of it has hard slope
	Cleanliness	100 %	Approximately \approx 95 % due to the sometimes-dusty climate
	urban equipment	Light Columns Wooden sofa Stone sofa Wooden Pergolas	Light Columns Wooden Sofa Wooden Pergolas
	Health	100% (behind 4 hospitals and 2 ambulatories around, nearest 500 m- 1500 m)	100% (There are five hospitals around, nearest one far 1250 m)
Social	Aging rates (older than 65)	21,5 % *	3.9 %**
	Housing Level	Medium and Luxury	Medium and Luxury
	Targeted social activities	Sitting Meeting Walking	Sitting Meeting Walking

Developed by authors.

*Ayuntamiento de Castellón de la Plana, distrito 7. Nacional de Estadística INE [consulted: 19/05/2023].

**Central Agency for Public Mobilization and Statistics CAMPAS, 2017, Cairo, <<https://ghdx.healthdata.org/organizations/central-agency-public-mobilization-and-statistics-capmas-egypt>> [consulted: 07/02/2023]

C) ENVIRONMENTAL: In Egypt, the annual precipitation does not exceed 5.5 mm, while in Spain, it can reach up to 90 mm. Also, there are more rainy days in Spain than in Egypt. As a result, it is necessary to provide rain protection in Spain but not in Egypt. The relative humidity in both countries is within the limits of thermal comfort (Frame IV).

The results of this article compare the accessibility of public spaces for the elderly in Egypt and Spain. Both countries have good urban planning and offer better access to public spaces. However, the social results in Spain are higher than in Egypt, as the percentage of elderly people are higher in Spain. Overall, both case stud-

ies show that creating an accessible urban space for the elderly is ideal. The study also highlights the importance of considering environmental factors such as heat, humidity, and solar radiation in urban design. The Mediterranean basin countries, including Egypt and Spain, share common characteristics that enable the exchange of experiences and the dissemination of design considerations and solutions for public spaces. The study emphasises the need to support the well-being, health, and social connection of the elderly in urban environments.

The temperature in Egypt is higher than in Spain. However, Egypt tends to get hotter in the summer and milder in the winter. On the other hand, Spain is relatively colder than Egypt during the winter months. The rate

FRAME IV. Environmental Climatic Comparison Criteria between the two cities.

Environmental Climatic dimension	Spain, Residential complex	Egypt, Garden Housing
Average day and night temperature		
	<p>Temperature is similar in both cities, but it increases slightly in Egypt, tending to heat in summer, mild in Winter.</p>	
Sunshine hours and sunshine percent		
	<p>The rate of sunshine in Egypt is higher than Spain, which requires the provision of shaded places and protection from direct sunlight, especially in the summer.</p>	
Monthly precipitation		
Monthly Rainy days		
	<p>Precipitation in Egypt do not exceed 5.5 mm per year, while it reaches 90 mm in the Spanish model, as well as the number of rainy days is more in Spain than in Egypt, so rain protection is necessary in Spain while it is not necessary in Egypt case study model.</p>	
Relative humidity		
	<p>Relative humidity is acceptable in both cities and within the limits of thermal comfort.</p>	
Average wind speed		
	<p>Wind speed in both cities is within safe limits and does not require protection treatments in these open spaces.</p>	

Developed by authors from data Windfinder, <<https://weather-and-climate.com/>> and <<https://www.windfinder.com/windstatistics/valencia>> [consulted: 07/03/2023].

of sunshine in Egypt is higher than in Spain. Therefore, protection from direct sunlight is necessary.

V. DISCUSSION AND FINAL CONSIDERATIONS: TOWARDS AN ACCESIBLE URBAN SPACE ADAPATED FOR THE ELDERLY

It is necessary to have an accessible urban space adapted for the elderly. Both Egypt and Spain have relatively the same results. Urban planning is good in both case studies, they offer better access to the public space. However, the social results in Spain are higher than in Egypt. In Egypt, the number of elderly people is relatively small, while in Spain. And in both cases, the elderly people have good access to public spaces. In conclusion, the accessibility for the elderly in both case studies is ideal for creating an accessible urban space for the elderly. The environment and climate can have a significant influence on the well-being of the elderly. It emphasises the importance of creating a pleasant and stimulating environment for the elderly, which can include planting trees, creating green spaces and gardens, and providing access to recreational activities.

We also mention the significance of adequate lighting, good air quality, and other amenities in reducing social isolation and improving the quality of life for the elderly. These environmental improvements are beneficial not only for the elderly but for all city dwellers, as they foster a sense of belonging and well-being, so it is important to consider these factors when planning for the accessibility and inclusion of older people in the urban space.

Based on the research, it is recommended to prioritise the development of accessible and inclusive urban spaces for the elderly, and it is important to design public spaces to promote well-being through certain facilities for the elderly (ANDERSON et al., 2017). The key factors critical to understanding the elderly population's needs highlighted are three essential needs: safety, support, and well-being (AHMED et al., 2023). This can be achieved by implementing the following recommendations:

1. Improve ease of access and movement: Ensure that public spaces have ramps, elevators, and clear pathways to accommodate individuals with mobility challenges. Install handrails and non-slip surfaces to enhance safety.
2. Provide suitable seating areas: Install shaded seating areas in public spaces to protect against sun-

light and rain. Consider the comfort and ergonomic design of the seating to cater to the needs of the elderly.

3. Incorporate green areas: Integrate green spaces, such as parks and gardens, into urban areas. These spaces can provide opportunities for relaxation, socialisation, and physical activity for the elderly.
4. Create outdoor recreational areas: Design public spaces that offer opportunities for walking, exercise, and social activities. Include amenities such as walking paths, exercise equipment, and designated areas for social gatherings.
5. Ensure maintenance and safety: Regularly maintain public spaces to ensure cleanliness, functionality, and safety. Address any potential hazards or obstacles that may hinder the accessibility and usability of the spaces.
6. Consider social activities: Promote the inclusion of social activities and events specifically tailored for the elderly. This can foster social connections, reduce isolation, and enhance overall well-being.

By implementing these recommendations, urban planners and policymakers can contribute to the creation of age-friendly cities and improve the quality of life for the elderly.

In conclusion, the growing population of elderly people globally underscores the importance of creating supportive public spaces that promote their well-being and quality of life. Importantly, the United Nations' Sustainable Development Goals prioritise caring for the elderly, highlighting the significance of this issue on a global scale. By examining two case studies, Egypt and Spain, it becomes evident that countries within the Mediterranean basin share several key characteristics that can facilitate the exchange of knowledge and best practices in designing public spaces to accommodate the elderly population.

Some of the fundamental design considerations for these public spaces include ensuring ease of access and mobility, providing comfortable and shaded seating areas, incorporating green spaces, and offering outdoor recreational areas for walking and social activities. By prioritising these considerations in the design of public spaces, cities and communities can create inclusive and welcoming environments for elderly individuals to socialise, engage in physical activity, and maintain a high quality of life as they age.

Ultimately, the cases studied here demonstrate the potential for countries in the Mediterranean basin to learn

from one another and disseminate best practices in designing public spaces that support elderly populations. By doing so, these countries can create more age-friendly and inclusive environments that better cater to the needs of this significant segment of society.

BIBLIOGRAPHY

- ABBAS, A., and S. HUSSEIN (2023): “Unveiling Baghdad’s Urban Identity: A Comprehensive Study on the Dynamics of Urban Imprint”, *Academia Open*, vol. 9, n° 2, <<https://doi.org/10.21070/acopen.9.2024.8238>>.
- AGENDA URBANA (2021): *Guía de accesibilidad en los espacios públicos urbanizados V.1.0*, Ministerio de Transportes, Movilidad y Agenda Urbana Secretaría General Técnica Centro de publicaciones, 83 pp.
- AHMED, M., N. HASSAN and E. MORGHANY (2023): “Towards Elderly-Friendly Home Environments in Egypt: Exploring Elderly Challenges, Needs, and Adaptive Strategies to Promote Aging in Place”, *JES. Journal of Engineering Sciences*, vol. 51, n° 4, pp. 260-286.
- ANDERSON, J., K. RUGGERI and F. HUPPERT (2017): “Lively social space, well-being activity, and urban design: findings from a low-cost community-led public space intervention”, *Environment and behavior*, vol. 49, n° 6, pp. 685-716.
- AYUNTAMIENTO DE CASTELLÓN DE LA PLANA (2016): *Ciudades amigables con las personas mayores*. Castellón de la Plana, 169 pp.
- (2023): “El municipio en cifras, Instituto Castellón de la Plana, distrito 7”, <http://portalestadistico.com/municipioencifras/pagina_servicio_externo_navegador.aspx?pn=castello&pc=NBH91&idp=241&idpl=0&idioma=>> [consulted: 19/05/2023].
- AYUNTAMIENTO DE MADRID (2022): *Manual de accesibilidad para espacios públicos urbanizados del Ayuntamiento de Madrid (versión 2022)*, Comunidad de Madrid, 432 pp., <<https://sid-inico.usal.es/documentacion/manual-de-accesibilidad-para-espacios-publicos-urbanizados-del-ayuntamiento-de-madrid-version-2022/>> [consulted: 10/05/2023].
- BLACK, J., and M. CONROY (1977): “Accessibility measures and the social evaluation of urban structure”, *Environment and Planning A*, vol. 9, n° 9, pp. 1013-1031.
- CENTRAL AGENCY FOR PUBLIC MOBILIZATION AND STATISTICS (CAPMAS) (2017): *Statistical Yearbook Population*, Cairo, Egypt, <https://capmas.gov.eg/Pages/StaticPages.aspx?page_id=5034> [consulted: 07/02/2023].
- DÁVALOS-PITA, A. (2022): “Universal accessibility in the streets of the territory: Urban District 4, Puerto Vallarta, Jalisco”, *Ra Ximhai*, vol. 18, n° 4, <doi.org/10.35197/rx.18.04.2022.11.ad>.
- DELGADO-ENALES, I., J. DEL SER and P. MOLINA (2023): “A framework to improve urban accessibility and environmental conditions in age-friendly cities using graph modeling and multi-objective optimization”, *Computers, Environment and Urban Systems*, vol. 102, <<https://doi.org/10.1016/j.compenvurbsys.2023.101966>>.
- FUNDACIÓN ONCE (2011): *Manual de accesibilidad para técnicos municipales*, Cooperación e Inclusión Social de Personas con Discapacidad. Madrid, 421 pp., <https://www.google.com/search?q=MANUAL+DE+AccESIBILIDAD+PARA+TECNICOS+MUNICIPALES&rlz=1C5CHFA_enES689ES689&oq=MANUAL+DE+AccESIBILIDAD+PARA+TECNICOS+MUNICIPALES&aqs=chrome.69i59j0i22i30.964j0j7&sourceid=chrome&ie=UTF-8> [consulted: 25/05/2023].
- GILROY, R. and A. SCHOFIELD (2015): “Age friendly cities and regions”, in R. Gilroy & M. Tewdwr-Jones (eds.): *Joining up the dots: Making healthcare work better for the local economy*, The Smith Institute and Regional Studies Association, pp. 57-63.
- HOUSING AND BUILDING NATIONAL RESEARCH CENTER (HBRC) (2017): “Egyptian Agency, code n° 601 for outdoor spaces and building design for handicaps”, Ministry of Housing, Utilities and New Urban Communities, Cairo, Egypt, 2015, <<http://www.hbrc.edu.eg>> [consulted: 13/05/2023].
- JARZEBSKI, M., T. ELMQVIST, A. GASPARATOS, K. FUKUSHI, S. ECKERSTEN, D. HAASE, J. GOODNESS, S. KHOSHKAR, O. SAITO, K. TAKEUCHI, T. THEORELL, N. DONG, F. KASUGA, R. WATANABE, B. SIOEN, M. YOKOHARI and J. PU (2021): “Ageing and population shrinking: Implications for sustainability in the urban century”, *Npj Urban Sustainability*, vol. 1, n° 17.
- JUNTA DE EXTREMADURA (2022): *Manual de accesibilidad universal para el sector de la construcción*, Consejería de Sanidad y Servicios Sociales, Junta de Extremadura, 85 pp., <<https://sid-inico.usal.es/documentacion/manual-de-accesibilidad-universal-para-el-sector-de-la-construccion/>> [consulted: 15/05/2023].
- KOUIDMI, F. (2022): *Evaluación de la vulnerabilidad del espacio público para lograr ciudades más inclusivas*

- para las personas mayores. Estudio de caso*, doctoral thesis, Jaume I University, Castellón, Spain, <<http://hdl.handle.net/10803/687348>>.
- LIU, Y., Y. GUO, S. LU, O. CHAN, H. CHUI, H. HO, Y. SONG, W. CHENG, R. CHIU, C. WEBSTER and T. LUM (2023): “Understanding the long-term effects of public open space on older adults’ functional ability and mental health”, *Building and Environment*, vol. 234, <<https://doi.org/10.1016/j.buildenv.2023.110126>>.
- LU, J., M. DAI, F. LI, L. QIN, B. CHENG, Z. LI, Z. YAO and R. WU (2023): “The Impact of Urban Built Environments on Elderly People’s Sense of Safety and Adaptation to Aging: A Case Study of Three Major Urban Agglomerations in China”, *Land*, vol. 12, n° 8, <<https://doi.org/10.3390/land12081486>>.
- NEW URBAN COMMUNITIES AUTHORITY, Sheikh Zayed City Development Authority, Giza, Egypt, <http://newcities.gov.eg/know_cities/Sheikh_Zayed/default.aspx> [consulted: 05/02/2023].
- O’BRIEN, E. (2014): “Planning for population ageing: Ensuring enabling and supportive physical-social environments – Local infrastructure challenges”, *Planning Theory & Practice*, vol. 15, issue. 2, pp. 220-234, <<https://doi.org/10.1080/14649357.2014.902986>>.
- OMS (2015): *Informe mundial sobre el envejecimiento y la salud*, Estados Unidos, 1211.
- PARKINSON, J., W. HUNTER and M. BARAC (2013): “Silver linings: The active third age and the city”, *RIBA*, retrieved 4 May 2021.
- PENG, S., and M. MAING (2021): “Influential factors of age-friendly neighborhood open space under high-density high-rise housing context in hot weather: A case study of public housing in Hong Kong”, *Cities*, vol. 115, <<https://doi.org/10.1016/j.cities.2021.103231>>.
- PHILLIPS, J., N. WALFORD, A. HOCKEY and L. SPARKS (2021): “Older People, Town Centers and the Revival of the ‘High Street’”, *Planning Theory & Practice*, vol. 22, issue. 1, p. 11-26, <<https://doi.org/10.1080/14649357.2021.1875030>>.
- RAVI, K., N. FIELDS and H. DABELKO-SCHOENY (2021): “Outdoor spaces and buildings, transportation, and environmental justice: A qualitative interpretive meta-synthesis of two age-friendly domains”, *Journal of Transport & Health*, 20, 100977, <<https://doi.org/10.1016/j.jth.2020.100977>>.
- SANTOS, A. (2022): Lisbon, Institute, Germany, Institute Italy, Department Latvia, Faculty Romania, Research. Canarias, Research. Portugal, Sociedade: *Re-place: reframing non-metropolitan left behind places through mobility and alternative development*, Proposal submitted to Call: [HORIZON-CL2-2022-TRANSFORMATIONS-01-02] – The impact of spatial mobility on European demographics, society, welfare system, <<https://cordis.europa.eu/project/id/101094087>>.
- SCOTT, M. (2021): “Planning for Age-Friendly Cities”, *Planning Theory & Practice*, vol. 22, issue. 3, pp. 457-492, <<https://doi.org/10.1080/14649357.2021.1930423>>.
- SHAN, W., C. XIU and R. JI (2020): “Creating a Healthy Environment for Elderly People in Urban Public Activity Space”, *International Journal of Environmental Research and Public Health*, vol. 17, n° 19, <<https://doi.org/10.3390/ijerph17197301>>.
- THANG, L., Y. YUI, Y. WAKABAYASHI and H. MIYAZAWA (2023): “Promoting age-friendly community of support and care in Japan’s aging neighborhood: The Nagayama model”, *Aging and Health Research*, vol. 3, n° 1, <<https://doi.org/10.1016/j.ahr.2022.100111>>.
- UN (2023): *Leaving No One Behind in An Ageing World, World Social Report, 2023*, Department of Economic and Social Affairs, <<https://www.un.org/development/desa/pd/content/publications>> [consulted: 10/03/2023].
- UN, SDGs, “Sustainable Development Goals”, <<https://sdgs.un.org/goals>> [consulted: 10/03/2023].
- VISOR DE ESPACIOS URBANOS SENSIBLES (VEUS): Cartographic viewer of the Valencian Community. Castelló de la plana localization, <<https://visor.gva.es/visor/index.html?idioma=es&capasids=VEUS;4,3,2,1,0>> [consulted: 15/05/2023].
- WHO (2007): *The world health report 2007: a safer future: global public health security in the 21st century*, World Health Organization.
- (2016): *World Health Statistics 2016 [OP]: Monitoring Health for the Sustainable Development Goals (SDGs)*, World Health Organization, 161 pp., <https://books.google.es/books?id=-A4LDgAAQBAJ&lpg=PP1&ots=dcpl_PboCD&dq=World%20Health%20Organization> [consulted: 07/03/2023].
- (2018): *Integrated care for older people. Realigning primary health care to respond to population ageing* (No. who-his-sds-2018.44), World Health Organization, 19 pp., <<https://www.who.int/publications/item/WHO-HIS-SDS-2018.44>> [consulted: 07/03/2023].
- WINDFINDER: datos meteorológicos históricos y observaciones de España y Egipto, <

- [finder.com/#3/49.5042/9.5421](https://doi.org/10.3390/ijerph182312618)> [consulted: 07/03/2023].
- ZHONG, W., J. SUO, X. REN and G. LI (2021): "The Influence of Emotional Health on the Activity Characteristics of the Elderly and the Selection of Environmental Quality Factors in Residential Areas", *International Journal of Environmental Research and Public Health*, vol. 18, n° 23, <<https://doi.org/10.3390/ijerph182312618>>.
- ZULFIDA, I., M. SITUMEANG and C. REIS (2023): "Analysis of Geography Planning and Village Funds to Improve Development Program", *Jurnal Geografi*, vol. 15 n° 1, pp. 90-99, <<https://jurnal.unimed.ac.id/2012/index.php/geo/article/view/38862>>.