

Using the Standard Electrodynamometer Wattmeter for Harmonic Power Measurement

Utilización del vatímetro electrodinámico estándar para la medición de potencia armónica

A. Veyrat Durbex ^{†*1}, Y. Nachajon Schwartz ^{†2} y H. Tacca ^{†3}

[†] *Laboratorio de Control de Accionamientos Tracción y Potencia (LABCATYP), Departamento de Electrónica, Facultad de Ingeniería, Universidad de Buenos Aires, Paseo Colón 850, C1063ACV, Buenos Aires, Argentina*

¹ aveyrat@fi.uba.ar

² ynachajon@fi.uba.ar

³ htacca@fi.uba.ar

^{*} *Departamento de Energía, Facultad de Ingeniería, Universidad de Buenos Aires
Paseo Colón 850, C1063ACV, Buenos Aires, Argentina*

Recibido: 29/03/23; Aceptado: 06/06/23

Abstract— Historically, for the measurement of electrical power, the wattmeter electrodynamometer was used, but when dealing with frequencies higher than those of power line, it was necessary to develop special equipment. Digital power meters are currently used.

This work studies the use of the electrodynamometer wattmeter in a very frequent application such as power measurement at the output of a frequency converter. Measurements are made by comparing the readings of this instrument with those of digital instruments in different scenarios, depending on the frequency, $\cos\phi$, load, etc., to determine under which conditions it is useful.

Keywords: electrodynamometer wattmeter; frequency converter; power measurement; power harmonics; power electronics.

Resumen— Históricamente para la medición de potencia eléctrica se utilizó el vatímetro electrodinámico, pero cuando involucraba frecuencias superiores a las industriales se debían desarrollar equipos especiales. En la actualidad se utilizan medidores digitales de potencia.

En este trabajo se estudia la utilización del vatímetro electrodinámico en una aplicación muy frecuente como es la medición de potencia a la salida de un convertidor de frecuencia. Se realizan mediciones comparando la lectura de este instrumento con la de instrumentos digitales en distintos escenarios, en función de la frecuencia, el $\cos\phi$, la carga, etc., para determinar en qué condiciones es de utilidad.

Palabras clave: Vatímetro electrodinámico; convertidor de frecuencia; medición de potencia; potencia de armónicas; electrónica de potencia.

I. INTRODUCTION

The ability to accurately measure electrical power is essential to determine the operating range of electrical equipment, its efficiency and reliability. Currently, the search for sustainable resource management drives the replacement of fossil fuels with electric power. It is in this scenario that the need to develop high-efficiency motors and controllers increases.

In these cases, pulse width modulation (PWM) techniques at high frequency and with high currents are widely used.

The power measurement in the aforementioned conditions is carried out with electronic instruments based on analog-digital conversion, which from the sampling of the analog variables at very high frequency allows the digital reconstruction of the magnitudes so that they can be processed by a DSP (digital signal processor) or another type of microcontroller, in order to obtain the value of the power by numerical calculation.

For many years, when high-power measurements were made at power frequencies, electrodynamometer (ED) wattmeters were used. Due to their popularity, it is common, even today, to find instruments of this type in most laboratories, especially in technical schools, academic institutions and state scientific laboratories in developing countries. In addition, because they do not have electrolytic capacitors, do not depend on auxiliary sources, have a very long useful life and are inherently robust against noise, ED wattmeters are still in use in some applications (such as in nuclear power plants). As a result, ED wattmeters are still being manufactured in some countries today [1], [2], [3], [4].

For this reason, it is interesting to study their response when used in measuring circuits with the presence of harmonic powers with frequencies higher than power line frequencies. In this work, the usefulness of these ED wattmeters for measurements at frequencies up to 16 kHz is analyzed.

II. THE ED WATTMETER AT 50HZ

This instrument is made up of a fixed system formed by a coil generally divided into two sections, to produce a uniform magnetic field that allows the mobile system to be housed in the middle of said field. The load current flows through this coil which is generally called the “current” coil.

The mobile system, made up of the “pressure” or “voltage” coil and the pointer, is mounted on a shaft with minimal friction. It is completely surrounded by the fixed coil. It is made of thin conductors, with an air core, and has high

resistance. The moving coil is connected between the load terminals in such a way that it is passed through by a current proportional to the load voltage.

The instantaneous torque that generates the angular deflection of the mobile system can be found from the energy of the field formed by both coils:

$$\tau_i = i_f \cdot i_m \cdot \frac{dM}{d\theta}, \quad (1)$$

Where i_f is the current flowing through the fixed coil and i_m through the moving one, $dM/d\theta$ is the derivative of the mutual inductance M with respect to the deflection angle θ . Considering that the time constant of the system is much greater than the period of the electrical variables and that the measurement reaches equilibrium when the mean deflecting torque becomes equal to the restoring torque $T_r = k \cdot \theta$ where k is the spring constant, one obtains:

$$\theta = \frac{dM}{d\theta} \frac{1}{k \cdot T} \int_0^T i_f \cdot i_m \cdot dt, \quad (2)$$

Assuming, ideally, that the moving coil is purely resistive, and substituting the current i_m by u_m/R_m in (2) it is concluded that the deflection is proportional to the power of the circuit in which it is measured.

For the sinusoidal case with $i_f(t) = \sqrt{2} \cdot I_{ef} \sin(\omega t - \varphi)$ and $i_m(t) = \sqrt{2} \cdot U_{ef}/R_m \sin(\omega t)$ substituting in (2):

$$\theta = k_w \cdot I_{ef} \cdot U_{ef} \cdot \cos\varphi = k_w \cdot P, \quad (3)$$

Which allows to see that the deflection is proportional to the active power.

The sources of error in electrodynamic wattmeters have been extensively studied. In [5] they are broken down between errors due to voltage or current separately, those that affect the product of both and those that affect the angle. Among the former are magnetic impurities in the mobile system that can cause deflections with currents only in the fixed coil, induced or capacitive currents in the moving system that increase with the square of the magnitude and frequency of the current through the fixed coil. The errors due to the U.I product, called errors at unity power factor, generally are discarded as being negligible at frequencies up to 3 kHz. In the case of phase angle dependent errors, the causes include eddy currents in the fixed coils or skin effect. Also, errors may be caused by capacitive couplings in the fixed coils and by phase errors in the voltage circuit due to a phase difference between the current that flows through the mobile coil and the voltage applied to it.

Similarly, in [6], the analysis of audio frequency measurements with electrodynamic wattmeters is carried out, emphasizing the shielding needs of the fixed and mobile system to prevent external magnetic fields from exerting a torque on the mobile system. The benefits of shielding with a compensation capacitor and the use of double shielding are evaluated.

In [7] the design and construction of an ED wattmeter for accurate measurements in the range of direct current to 20 kHz is discussed. The main effort in the construction of this instrument was devoted to obtain a sufficient torque with low number of turns in the current and potential windings, paying attention to their shapes and physical arrangement to minimize the interaction effects of the moving and fixed coil fields. To reduce capacitive influences at high frequencies,

the potential coils were wound with paper inserts. The current coils are made with individually twisted and lacquered conductors to avoid eddy currents.

Another design can be found in [8]. Where the moving system of the comparator is in the form of a transverse horizontal beam, acting as a balance, on the edges of which plane coils of two identical electrodynamic transducers are fastened, while their fixed coils are connected rigidly to a beam parallel to the base of the comparator, the suspension of the mobile system takes the form of four tension wires, the electrodynamic transducer is in the form of flat coils. This comparator is an extremely sensitive measuring instrument. This enable only a small number of windings to be used in the transducers and consequently it will have a low inductance, giving the instrument a wide range of measurement values and frequencies.

This brief review of history accounts for the effort to optimize the system, make compensations and corrections in order to increase the frequency range of electrodynamic type wattmeters. Without these improvements, the instruments only guarantee the class of accuracy within the kHz range. In Fig. 1 the percentage change in the reading due to the frequency, presented by a manufacturer, can be observed.

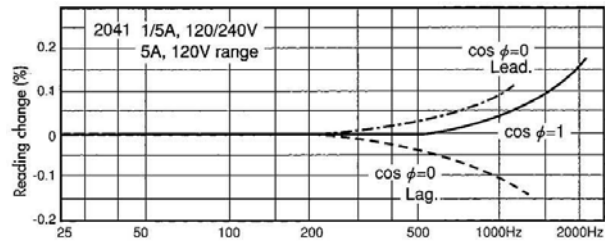

Fig. 1. Error increase with increasing frequency [Source: Yokogawa Portable Wattmeters 2041, 2042].

It can be noted that a class 0.5 instrument, for example, will measure at frequencies of the order of 2 kHz but with an accuracy of the order of 1% of the full scale value.

III. THE ED WATTMETER WITH POLYHARMONICS

When it is required to measure power in systems with distorted voltages and/or currents [9], power can be expressed as:

$$P = U_0 \cdot I_0 + \sum_{k=1}^{\infty} U_k \cdot I_k \cdot \cos(\varphi_k^u - \varphi_k^i), \quad (4)$$

Where U_0 and I_0 are the DC components of the voltage and current respectively, U_k is the rms value of the k-order harmonic component of the voltage, I_k is the rms value of the k-order current component, and φ_k^u, φ_k^i are the phases of the components of order k of the voltage and current respectively. The cross products between voltage and current harmonics of different frequencies are zero due to orthogonality between sinusoidal functions that are multiples of the same frequency.

It can be noted that the total power within a given bandwidth is the sum of the DC power plus the sum of the active powers due to each harmonic frequency, which means that the electrical magnitude with the narrower harmonic distortion bandwidth determines the final bandwidth of the power signal.

A very frequent situation is the need to measure power with sinusoidal voltage applied from the electrical grid and with nonlinear current load. Another case would involve converters used for electrical machines that use PWM voltage with sinusoidal currents. Note that in these cases, ideally, the necessary bandwidth would be the same as for power frequency measurement.

In [10] comparative power measurements were made between an electrodynamic wattmeter, an electronic wattmeter with analog operating principle and an energy meter, connected to the input of a half-wave rectifier (where a DC component is present) and with a thyristor controlled rectifier, with load R, R-L and R-C. From this comparative test, the author concludes that the electrodynamic instrument measures accurately. However, even when the harmonic content of the variables has frequencies greater than 50 Hz, it is much lower than the harmonic content present in PWM inverters.

In practice, none of the variables is perfectly sinusoidal, but the harmonic distortion can be very low. For example, in frequency converters used in induction motors with carriers of a few kHz in voltage, the greater the inductances of the machine and the higher the switching frequency, the lower the current distortion will be (Fig. 2).

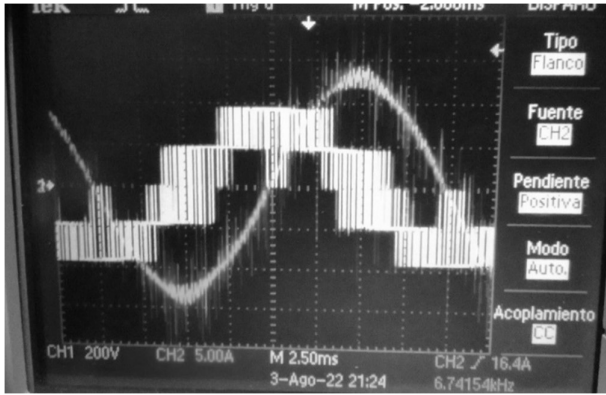

Fig. 2. Pulse Width Modulated (PWM) voltage and current drawn by an induction motor.

It is not an easy task to determine what will be the necessary bandwidth in each case. The distribution of the losses in the frequency spectrum depends on the fundamental frequency, the switching frequency, the type of drive control, the geometry of the machine and the laminations used, the state of load, etc.

The phenomenon of losses in machines using converters has been studied using different approaches, with computational techniques based on finite elements such as [11], [12]; using analytical models [13] or empirical methods [14].

Due to this, the standards do not have a single criterion for the treatment of the subject either. They consider the increase in motor losses due to the use of the converter, but there is no standard that specifies the test procedure to evaluate the efficiency of the system [15].

The NEMA MG1 Part 30 [16] standard considers a power derating factor to avoid overheating using the converter, depending on the harmonic content of the PWM voltage. IEC 60034-17 [17] proposes as an example a motor with a 315 frame with 95.3% efficiency and breaks down the

components of the increase in losses due to the use of a drive, which are 15% higher than rated losses.

If this example is considered to determine the necessary bandwidth in power measurement and taking into account that this increase in losses occurs in the switching frequency bands and their multiples, since the difference between the losses in the band of the fundamental frequency of a 50Hz sinusoidal excitation and a PWM excitation is marginal [11], it is expected that the reduction in accuracy suffered by the electrodynamic wattmeter at high frequencies affects only that additional 15% of power. In addition, although the measurement error increases with frequency, the power loss decreases, according to [11] these losses are found mainly in the switching frequency band (f_{sw}) and to a lesser extent in the first multiple of this ($2 \cdot f_{sw}$), being totally negligible for $3 \cdot f_{sw}$. Considering this, and assigning an average error of 10% of the wattmeter in the high part of the spectrum, this would introduce an error of 1.5% in the measurement of the total power loss p_{total} (9), and if the measurement is made on the input power of the machine P_i , the error is negligible (10).

Separating the losses in the fundamental band, from those due to the harmonic components (which are indicated by the subscript HF for high frequency):

$$p_{total} = p_{50Hz} + p_{HF} \quad (5)$$

$$p_{50Hz} = P_i \cdot (1 - 0.953) = P_i \cdot 0.047 (\pm \varepsilon_{50Hz}), \quad (6)$$

$$p_{HF} = p_{50Hz} \cdot 0.15 (\pm \varepsilon_{HF}), \quad (7)$$

$$\varepsilon_{HF} = p_{50Hz} \cdot 0.15 \cdot 0.1 = p_{50Hz} \cdot 0.015, \quad (8)$$

Replacing (7) in (5):

$$p_{total} = p_{50Hz} (\pm \varepsilon_{50Hz}) + p_{50Hz} \cdot 0.15 (\pm \varepsilon_{HF})$$

If the contribution to the error of the harmonic power measurement is the only one considered (that is, the error at 50 Hz is not taken into account):

$$p_{total} = p_{50Hz} \cdot (1 + 0.15)$$

$$\varepsilon_{p_{total}} = p_{50Hz} \cdot 0.015 = p_{total} \cdot \frac{0.015}{(1+0.15)}$$

$$= p_{total} \cdot 0.013, \quad (9)$$

If it is evaluated how much the error of the ED wattmeter affects the measurement of the input power:

$$\begin{aligned} \varepsilon_{P_i} &= P_i \cdot (1 - 0.953) \cdot 0.15 \cdot 0.1 \\ &= P_i \cdot 0.000705, \end{aligned} \quad (10)$$

The proportion of losses caused by harmonics when using PWM depends on many variables: The load condition of the machine, the fundamental frequency, the modulation index, the modulation strategy, etc.

Assuming a machine with low efficiency of the order of 80%, and losses increased by harmonics by 50%, the error of the wattmeter in the measurement of the total loss power will be 3.33%, while for the input power it will be 1%.

In general:

$$\varepsilon_{p_{total}} = p_{total} \cdot \frac{k}{(1+k)} \cdot \varepsilon_W, \quad (11)$$

$$\varepsilon_{P_i} = P_i \cdot (1 - \eta) \cdot k \cdot \varepsilon_W, \quad (12)$$

Where k is the increase in losses in per unit due to the use of the drive, η is the rated efficiency for 50Hz sinusoidal and ϵ_W the average estimated error of the wattmeter at harmonic frequencies.

It is interesting to note that to determine the efficiency of a motor, estimation methods are sometimes used, for example "slip method" or "current method" [18], which provide greater errors than those mentioned. More complex methods [19] produce errors of the same order. If the intention is to measure power losses by some segregation method [20], the accuracy will not be sufficient. It will be necessary to evaluate in each particular case whether the resulting errors are acceptable or not.

IV. LABORATORY MEASUREMENTS

The experimental results were obtained using three setups for power measurement under different conditions.

The first setup (A) can be seen in Fig. 3. An Agilent 6834B AC Power Source/Analyzer 4500VA with a power measurement error of [0.15% + 3 W] is used to power a three phase resistive load bank and a three phase inductive load bank connected in parallel. The tested wattmeters are connected individually and their reading is compared with the one provided by the power source, which has an external sensing feature to measure the voltage on the load.

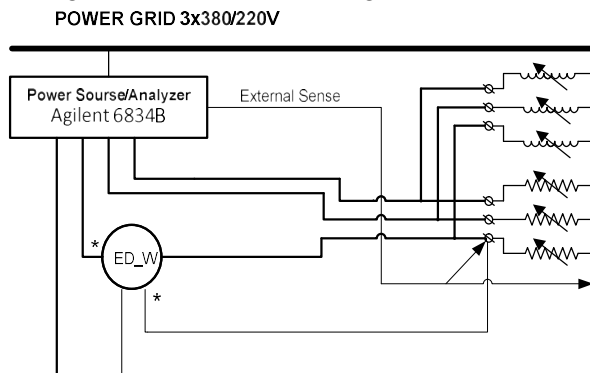

Fig. 3. Measurement setup A.

Fig. 4 shows the simplified circuit of the test bench used for power measurement with harmonic content (configuration B) [21], [22]. A frequency converter (Siemens Micromaster440) drives a 3kW 220/380V 18.4/10.6A 715rpm "Mocbos" induction motor that is mechanically coupled to a "Motortech" 5.5KW 220V DC generator. This is connected to the power grid through a non-autonomous inverter (Mocbos ST 3630 controlled rectifier) to allow the regeneration of the energy used during the tests. The measurement with the tested ED wattmeters is carried out at the drive output, comparing the readings with a Yokogawa WT200 Digital Power Meter whose bandwidth is 50 kHz and whose error at 50 Hz is $\pm (0.15\% \text{ of rdg} + 0.1\% \text{ of rng})$ and about double at 10 kHz.

The third setup (C), graphed in Fig. 5, allows testing the wattmeters with PWM voltage and, in turn, with variation of cosine ϕ . To do this, a three-phase rotor induction phase shifter is used (2 kVA Siemens-Schuckert, 225 V 7.8 A / 110V 10.6 A) whose primary is connected to a WEG model CFW 09 converter while its secondary is connected to a pure resistive load. The voltage connection of the instruments is

made on an input phase and the current of the corresponding secondary phase flows through the current circuit of the instruments.

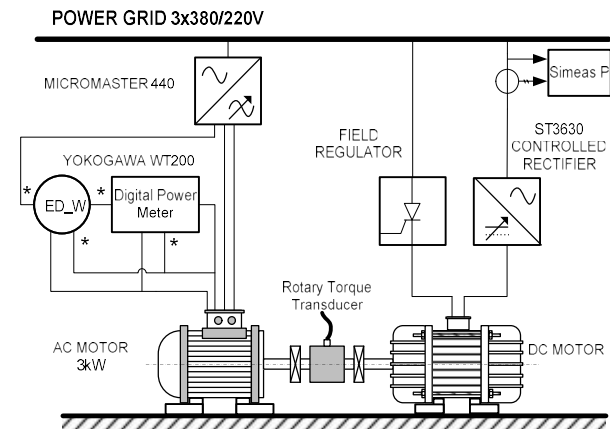

Fig. 4. Measurement setup B.

In all cases, "short connection" is used, that is, the instruments measure, in addition to the power dissipated in the load, the power consumed by the voltage circuit, but no correction is made since the instrument used for comparison measures the same power.

Then, the difference between the reading of the ED wattmeter and the reference wattmeter is calculated and the percentage that it represents with respect to the full scale (FS) value of the tested instrument is plotted.

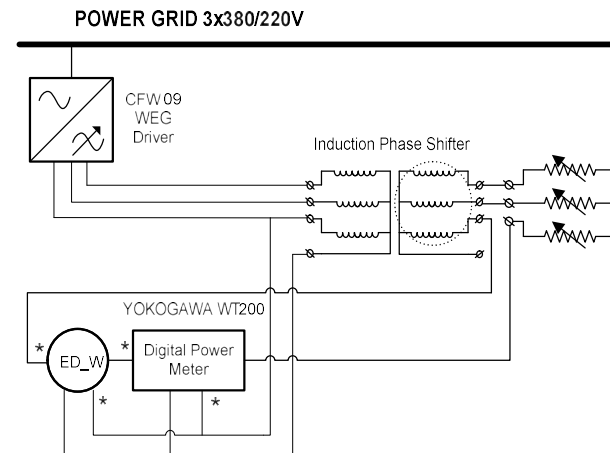

Fig. 5. Measurement setup C.

Three electrodynamic wattmeters with markedly different date of manufacture were tested.

A Weston model 310 No. 11499 dating from the year 1946 from the USA, whose class originally is 0.25 and at 50 Hz it verifies that the deviations are within 0.25% of the full scale value with respect to the measurements made with the standard. Even so, it cannot be affirmed that it is in class, since an evaluation of the uncertainty of the calibration is not carried out, considering that the standard does not have a sufficiently better accuracy than the instrument. However, the comparison is useful to evaluate how the errors evolve later when testing it under different harmonic conditions.

A Pullin N°S50232 of English origin dating from 1962. Original class 0.6, although it is verified that at 50 Hz the error doubles the 0.6% of the full scale reading.

A Yokogawa No. 80AN0167 from the year 2010 that retains its original Class 0.5.

A. 50Hz sinusoidal measurement

The first tests were carried out with (A) setup (Fig. 3).

The results show that in all three cases the wattmeters measure with an increasing error trend as a function of power. That is to say, the wattmeters under-measure for low loads, but as the current increases (at constant voltage), this tendency is reversed and reading becomes an over-measure. These deviations occur within the rated error of the WESTON wattmeter (Fig. 6) and the YOKOGAWA (Fig. 8), but the PULLIN (Fig. 7) exceeds the rated error in excess, doubling it.

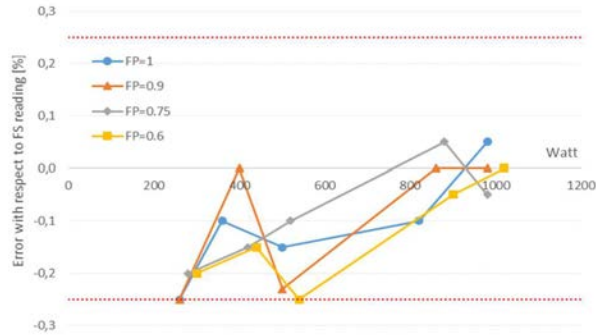

Fig. 6. WESTON wattmeter error with 50 Hz sinusoidal voltage as a function of load.

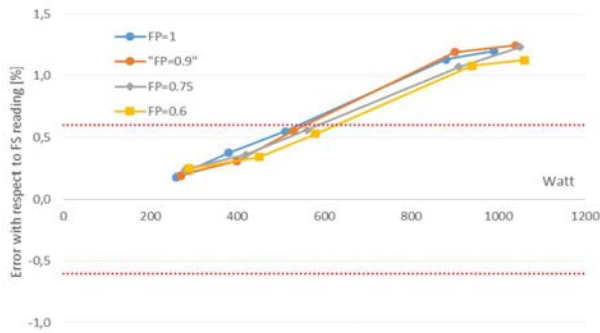

Fig. 7. PULLIN wattmeter error with 50 Hz sinusoidal voltage as a function of load.

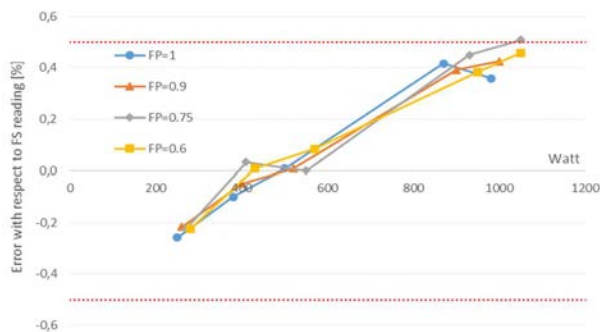

Fig. 8. YOKOGAWA wattmeter error with 50 Hz sinusoidal voltage as a function of load.

B. 5kHz sinusoidal measurement

Making use of the 5 kVA three-phase source in single-phase mode, using a sinusoidal waveform and with a pure

resistive load, the three wattmeters are tested at frequencies of 2 kHz, 4 kHz and 5 kHz.

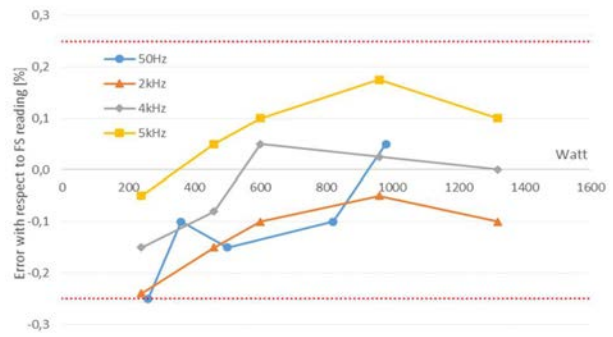

Fig. 9. WESTON wattmeter error with sinusoidal voltage as a function of the load for different frequencies.

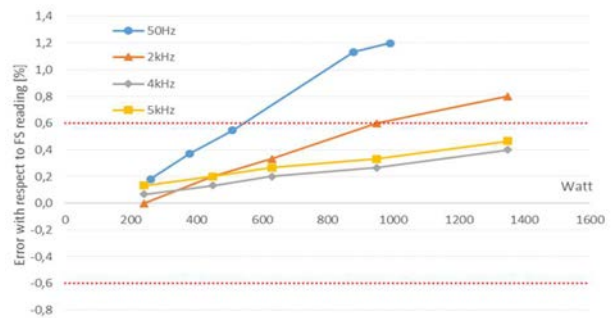

Fig. 10. PULLIN wattmeter error with sinusoidal voltage as a function of the load for different frequencies.

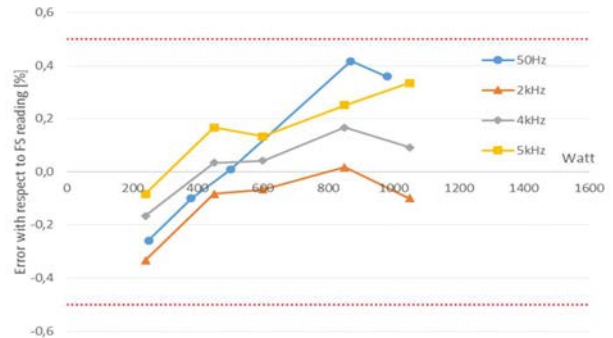

Fig. 11. YOKOGAWA wattmeter error with sinusoidal voltage as a function of the load for different frequencies.

An unexpected result is obtained. Despite the existence of a dispersion in the error values with respect to the measurements at 50 Hz, these remain within the same order of magnitude as at 50 Hz. The Yokogawa wattmeter (Fig. 11) remains within its class of accuracy. It shows a change in trend at around 2 kHz (similarly to the WESTON wattmeter, see Fig. 9) since at that frequency the measurement error (which is an under-measurement) reaches its maximum value, whereas for higher frequencies the trend changes and the error becomes an over-measurement. In the case of the PULLIN wattmeter (Fig. 10) the same change in trend occurs at 4 kHz. A possible explanation would be the following: as the frequency increases, the applied voltage in the potential coil cannot maintain the same current, since the inductance grows linearly with the frequency, and

as a result the instrument measures less. For higher frequencies, the errors due to parasitic and capacitive currents, which depend on the square of the frequency, have a greater influence compared to the previous effect, resulting in an over-measurement.

C. 2kHz polyharmonic measurement

A more demanding test involves square wave voltage and current measurement at 50 Hz and an approximately square wave polyharmonic with fundamental at 2 kHz (Fig. 12) performed with (A) setup.

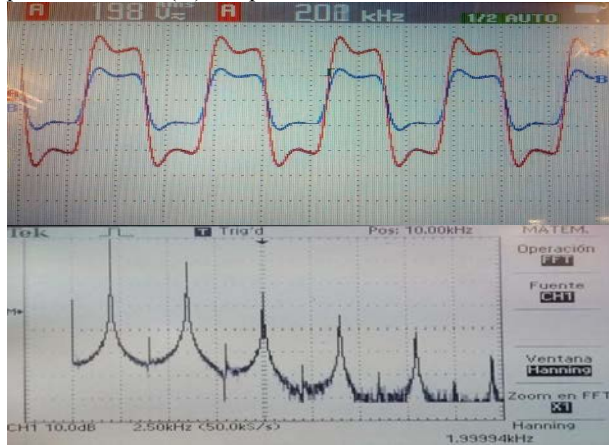

Fig. 12. Above: Polyharmonic current and voltage waveform with 2 kHz fundamental. Bottom: Voltage spectrum.

The results can be seen in the graphs (Fig. 13-14-15). The measured power (with 50 Hz square wave voltage and current) shows a variation in the error with respect to that obtained with 50 Hz sinusoidal due to the presence of polyharmonics. However, the difference is not significant, as the errors are of the same order.

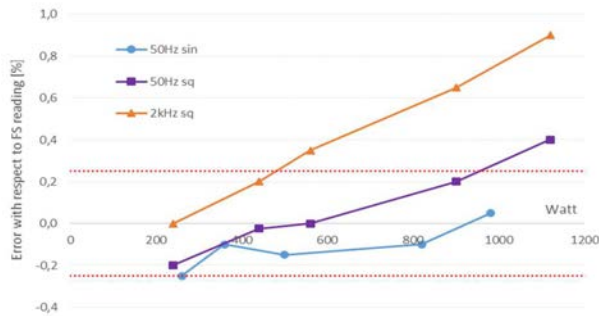

Fig. 13. WESTON wattmeter error with squared voltage (approx.) as a function of load for different frequencies.

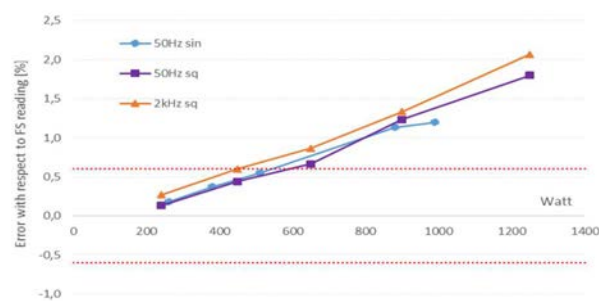

Fig. 14. PULLIN wattmeter error with squared voltage (approx.) as a function of load for different frequencies.

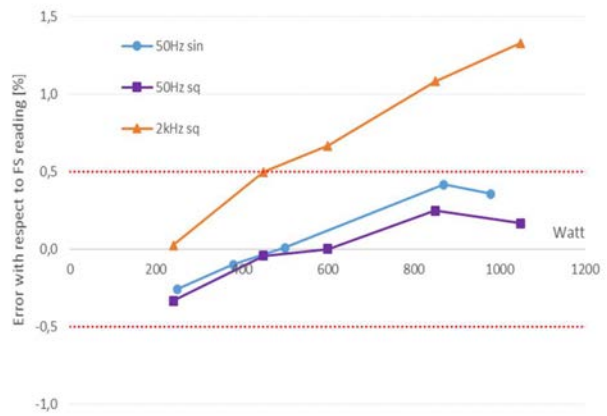

Fig. 15. YOKOGAWA wattmeter error with squared voltage (approx.) as a function of load for different frequencies.

On the other hand, it can be seen that the measured power with polyharmonic voltage and current (with a fundamental at 2 kHz) shows a significant deviation with respect to the readings of similar power measurements at 50 Hz. This trend in the YOKOGAWA wattmeter (Fig. 15) shows an error that, in the worst case, practically triples the class of accuracy at 50 Hz. Something similar occurs with the WESTON wattmeter (Fig. 13). In figure 12 it can be seen that the voltage contains odd harmonics of appreciable magnitude, the 11th (22 kHz) having an amplitude of approximately 30% of the fundamental frequencies. Even so, in all cases the error remained below 2% of the full scale value.

D. PWM polyharmonic measurement

The most relevant case results from the measurement of a PWM-type polyharmonic voltage (common in converters) and current with low distortion (due to the filtering effect of the electric machine, which in this case is a 3kW induction motor with four pairs of poles). It can be seen in (B) setup that the converter used is a Siemens Micromaster 440 model with the ability of configuring the switching frequency between 2 kHz and 16 kHz in steps of 2 kHz. The measurement of the errors committed by the three wattmeters under four load conditions and for five carrier frequencies was carried out. The readings obtained were compared with those obtained with the digital power meter YOKOGAWA WT200 which has a bandwidth of 50 kHz.

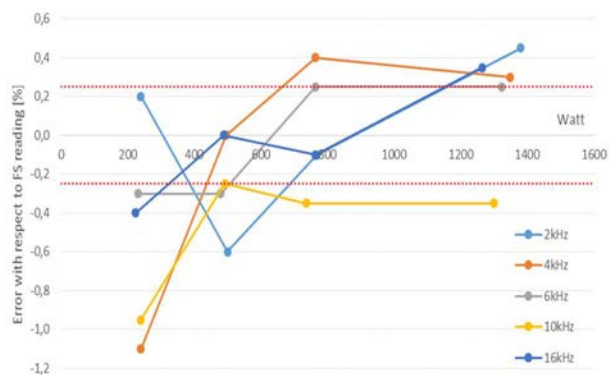

Fig. 16. WESTON wattmeter error with PWM voltage as a function of load for different frequencies.

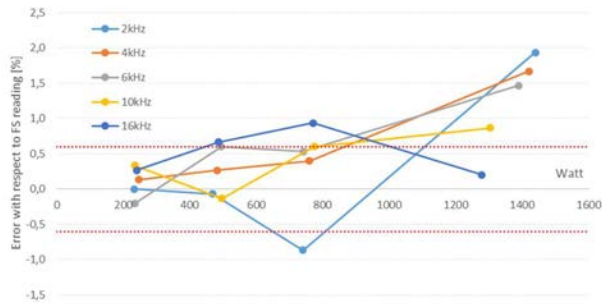

Fig. 17. PULLIN wattmeter error with PWM voltage as a function of load for different frequencies.

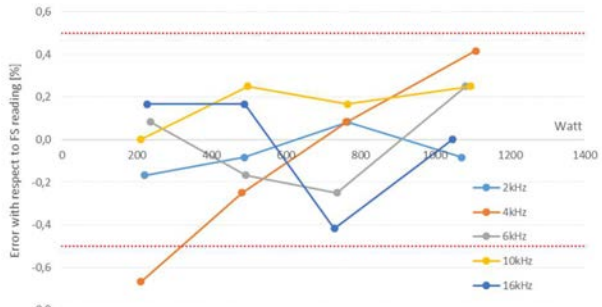

Fig. 18. YOKOGAWA wattmeter error with PWM voltage as a function of load for different frequencies.

In this case, the accuracy of the readings is limited by the instability of the measurement. To minimize the observer's error, the hold function of the digital instrument was used, in synchronization with the photographic capture of the measurement scale of the analog instrument.

From the analysis of the results, it can be affirmed that the errors are higher than those committed by the instruments at a frequency of 50Hz; even so they do not reach 2%. And, in the case of the YOKOGAWA wattmeter (Fig. 18) it does not deviate much from 0.5% original error. It is also observed that the maximum deviations occur for low carrier frequencies, 4 kHz in the case of the WESTON and YOKOGAWA wattmeters, and 2 kHz in the case of the PULLIN wattmeter. Regarding the trend of variation of the error with the load, the three wattmeters reproduce the behavior at 50Hz, where it was seen that the readings had tendency to over-measure for higher load values.

E. PWM polyharmonic measurement for different cos φ

Using (C) setup, the measurement made by the ED YOKOGAWA wattmeter was compared with the digital power meter reading when PWM voltage is applied and the current has low harmonic distortion, and varying the phase shift between them, that is, $\cos\phi$, where ϕ is the angle between the current and the fundamental of the switched voltage. To do this, a three-phase phase shifter is used to whose primary a WEG CFW 09 converter is connected and to whose secondary a pure resistive load is connected. Measurements were carried out for the drive's four configurable carrier frequencies: 1.25 kHz, 2.5 kHz, 5 kHz, and 10 kHz. As the secondary emf remains constant for a given load, the current also remains constant. Then, by manually turning the rotor the desired phase shifts are

obtained. This scenario allows testing the wattmeter in the combined presence of reactive power and distortion power.

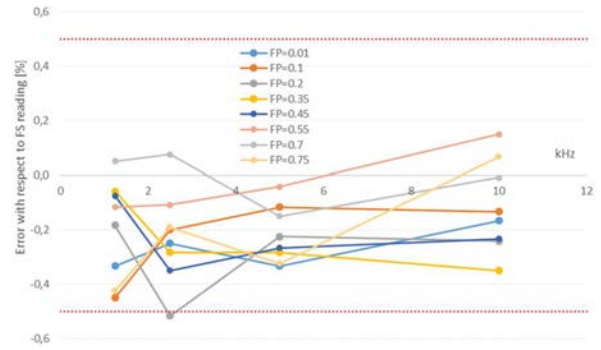

Fig. 19. YOKOGAWA wattmeter error with PWM for different FP depending on the carrier frequency.

In Fig. 19 the results are plotted, verifying that the measurements with the electrodynamic wattmeter differ from those obtained with the digital power meter in the order of 0.5% of the full scale reading.

This scenario that involves the measurement of power with a polyharmonic voltage waveform and a current waveform with low harmonic distortion, out of phase with each other, can be seen in figure 20.

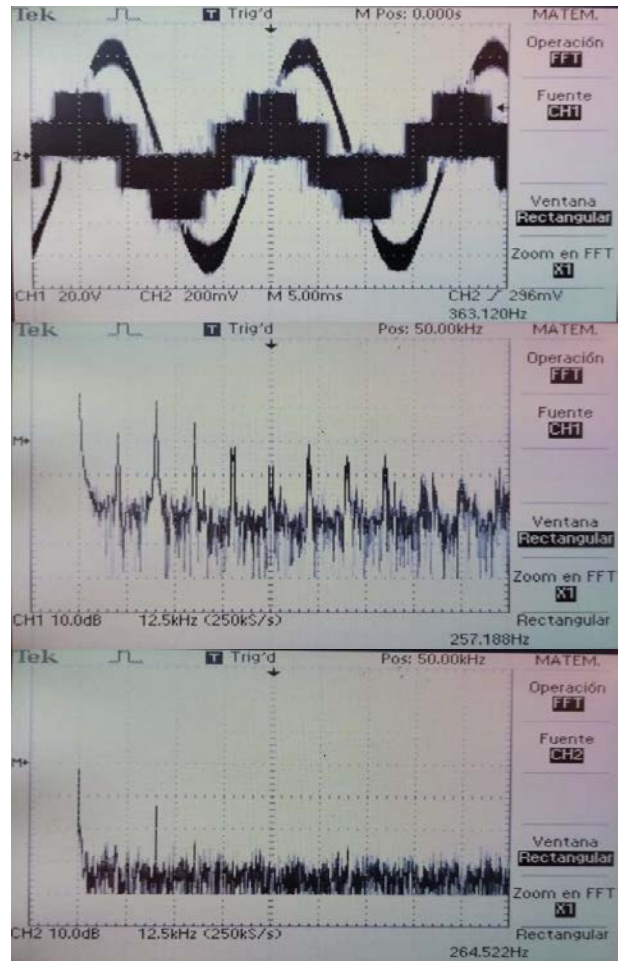

Fig. 20. Above: Current and voltage waveform. Bottom: Image shows voltage and current harmonic content from a PWM measurement.

F. Unitary PF PWM Polyharmonic Measurement

In Section III it was said that the electrical quantity with the narrowest harmonic distortion bandwidth determines the final bandwidth of the power signal. Power measurements made with PWM voltage waveforms and current waveforms with low distortion show low errors in ED instruments. To verify the response of the ED wattmeters with the PWM voltage and current polyharmonic waveform, measurements were made with frequencies up to 10kHz with resistive load, but for these frequencies, the load bank made with nichrome wire wound on ceramic cores have an inductive component that distorts the test. As an alternative, the measurement of a fixed load of 400W obtained with three star-connected halogen lamps was carried out. Three readings were made for each carrier frequency available in the drive (1.25 kHz, 2.5 kHz, 5 kHz, 10 kHz).

The figure 21 shows the error increase when the drive switching frequency increases.

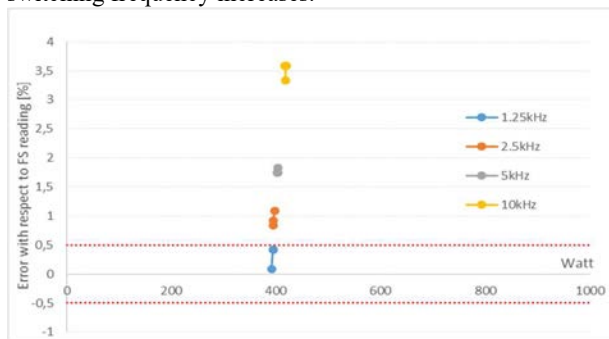

Fig. 21. YOKOGAWA wattmeter error with PWM voltage and current waveform for different frequencies.

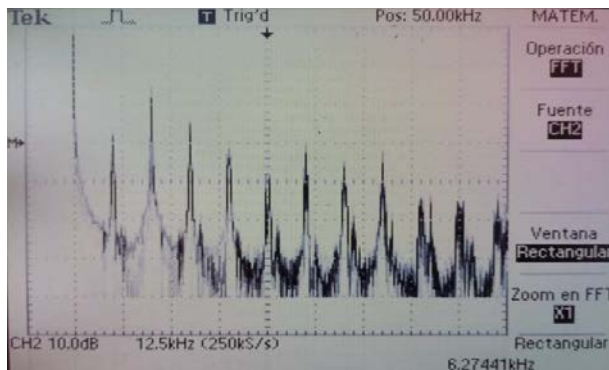

Fig. 22. Current harmonic content from a unitary PF PWM measurement.

V. CONCLUSIONS

Power measurements made with ED instruments involving voltages and currents with harmonic components of frequencies higher than the power grid frequency deviate from wattmeter readings made at 50Hz with sinusoidal voltage and current. These deviations in readings for frequencies of up to 5 kHz are similar to the deviations obtained at 50 Hz with $\cos\phi=1$ with a sinusoidal waveform.

When power measurements made with ED instruments involve voltages and currents with high harmonic content (greater than 20 kHz), significant deviations are recorded with respect to measurements of equal power made at a frequency of 50 Hz. In all cases the tendency was to over-

measure, this deviation reached, in some instruments, three times the class error.

For the very common case involving converters, of PWM voltage and quasi-sinusoidal current, the errors (compared to the 50Hz case) are minimal when the converter uses high-frequency carriers, and increase slightly when the converter uses low frequency carriers. Regarding the variation of error with load, ED instruments have a tendency to over-measure as load increases, such as occurs at 50Hz.

When both the voltage and current waveforms have high harmonic content, the error grows significantly.

In short, if an accurate measurement of the losses of a converter-driven machine is required, it will be necessary to evaluate if the errors obtained with the use of ED wattmeters are acceptable, or whether to resort to an expensive high-bandwidth digital wattmeter. If an estimate of the losses or efficiency of the machine is required, the ED wattmeter will suffice, more so if only a measurement of the input power supplied by the converter to the machine is required.

ACKNOWLEDGMENT

This work has received funding from the University of Buenos Aires with funds from the UBACYT grant 20020170100386BA. “New structures and simulation and control techniques for static converters and pulse generators”.

REFERENCES

- [1] (2023) Standard Electric Works Co. LTD. webpage. [Online]. Available: <http://www.sew.com.tw/front/bin/ptdetail.phtml?Part=1-13-01-05&Category=431933>
- [2] (2023) Mahesh Electrical Instruments webpage. [Online]. Available: <http://www.meinstruments.in/portable-meters-electrical-laboratory-meters--767151.html>
- [3] (2023) MECO-G webpage. [Online]. Available: <http://www.goliyainstruments.com/product-details/ANALOG-ELECTRODYNAMOMETER-TYPE-PORTABLE-WATT-VAR-POWER-FACTOR-METERS>
- [4] (2023) TESCA webpage. [Online]. Available: <https://www.tescaglobal.com/categories/analog-portable-meters>
- [5] J.H. Park, A.B. Lewis, “standard electrodynamic wattmeter and AC-DC transfer instrument”, National Bureau of Standards, U.S. Department of Commerce, research paper RP1344, vol 25, november 1940.
- [6] A. H. M. Arnold, “Audio Frequency Power Measurements by Dynamometer Wattmeters”, paper No 1653 M, April 1954.
- [7] R. Friedl and G. Wolf, “Precision Mesuring Equipment for Electrical Power in the Range of Audio Frequencies”, IEEE Transactions on Instrumentation and Measurement, VOL. IM-15, N° 4, December, 1966.
- [8] A. I. Nefed’ev, “A new method of constructing electrodynamic voltage, current, and power comparators”, Measurement Techniques, Vol. 50, N° 3, 2007.
- [9] S. Yoshizaki, “Bandwidth and Phase Characteristic Requirements for High-Precision Power Measurement of High Frequency and High-Current PWM Control Inverters”, Yokogawa Test&Measurement Corporation, June 2021.
- [10] George C. Laventure Jr., “Measuring Accurately Single-phase Sinusoidal and Non-sinusoidal Power”, Thesis, University of Colorado, 1983.
- [11] C. A. Hernandez-Aramburo, T. C. Green and S. Smith, "Assessment of power losses of an inverter-driven induction machine with its experimental validation," in *IEEE Transactions on Industry Applications*, vol. 39, no. 4, pp. 994-1004, July-Aug. 2003, doi: 10.1109/TIA.2003.813744.
- [12] K. Yamazaki, A. Suzuki, M. Ohto and T. Takakura, "Harmonic Loss and Torque Analysis of High-Speed Induction Motors," in *IEEE Transactions on Industry Applications*, vol. 48, no. 3, pp. 933-941, May-June 2012, doi: 10.1109/TIA.2012.2191252.

- [13] Y. Liu and A. M. Bazzi, "A General Analytical Three-Phase Induction Machine Core Loss Model in the Arbitrary Reference Frame," in *IEEE Transactions on Industry Applications*, vol. 53, no. 5, pp. 4210-4220, Sept.-Oct. 2017, doi: 10.1109/TIA.2017.2695442.
- [14] L. Aarniovuori, A. Kosonen, M. Niemelä and J. Pyrhönen, "Frequency converter driven induction motor losses," *IECON 2013 - 39th Annual Conference of the IEEE Industrial Electronics Society*, 2013, pp. 2881-2886, doi: 10.1109/IECON.2013.6699588.
- [15] *Motores de inducción alimentados por convertidores de frecuencia PWM*, Guía Técnica, WEG, 01/2016.
- [16] *Performance Standards Applying to All Machines – Part 30: Application Considerations for Constant Speed Motors Used on a Sinusoidal Bus with Harmonic Content and General Purpose Motors Used with Adjustable Voltage or Adjustable Frequency Controls or Both, Application Considerations*, ANSI/NEMA MG1-2016 (Revised 2018).
- [17] *Rotating electrical machines – Part 17: Cage induction motors when fed from converters – Application guide, Ed. 4*, IEC 60034-17, May 2006.
- [18] A. Jurado, J. P. Robbiano, F. Ferreyra, "Determinación in situ de la eficiencia de un motor eléctrico," Encuentro Latinoamericano de Uso Racional y Eficiente de la Energía - ELUREE2013. Buenos Aires, Argentina – 25, 26 y 27 de Septiembre de 2013. GT04 – Eficiencia en la Industria y Generación Eléctrica. **ISBN:** 978-987-1527-71-1. Croquis SRL.revista Electrotécnica AEA.
- [19] V. Sousa Santos, E. C. Quispe, J. R. Gómez Sarduy, P. R. Viego, N. Lemozy, A. Jurado and M. Brugnoli, "Bacterial Foraging Algorithm Application for Induction Motor Field Efficiency Estimation under Harmonics and Unbalanced Voltages," *IEEE International electric machines and drives conference*, Chicago, EEUU. 12-15 de mayo 2013 **ISBN:** 978-1-4673-4975-8; p. 1174-1177. IEEE.
- [20] *IEEE Standard Test Procedure for Polyphase Induction Motors and Generators*, IEEE Std 112-2017 (Revision of IEEE Std 112-2004), pp.1-115, 14 Feb. 2018, doi: 10.1109/IEEESTD.2018.8291810.
- [21] Y. Nachajon, P. Witis, G. Bongiovanni, H. Tacca, and F. Ferreira, "Banco de ensayos para algoritmos de control para motores de inducción trifásicos", SAAEL, Guijón-España, 2006.
- [22] A. F. Veyrat Durbex, "Cargas activas para un banco de ensayos de control de motores de inducción trifásicos," Thesis, Universidad de Buenos Aires, march of 2015.